

**FINAL REPORT ON THE ACCIDENT OCCURRED
ON 25 MAY 2008
AT BRUSSELS AIRPORT ON A BOEING
B747-209F REGISTERED N704CK**

Ref. AAIU-2008-13
Issue date: 10 July 2009
Status: Final

10 July 2009

Table of Content.

Foreword.....	2
Synopsis.....	3
1. Factual information.....	4
1.1. Chronology of the events.....	4
1.2. Injuries to persons.....	6
1.3. Damage to aircraft.....	6
1.4. Other damage.....	9
1.5. Personnel information.....	9
1.6. Aircraft information.....	11
1.7. Meteorological information.....	16
1.8. Aids to Navigation.....	17
1.9. Communication.....	17
1.10. Aerodrome information.....	22
1.11. Flight Recorders.....	30
1.12. Wreckage and Impact information.....	38
1.13. Medical and pathological information.....	38
1.14. Fire.....	39
1.15. Survival Aspects.....	39
1.16. Test and Research.....	40
1.17. Organisational Aspects.....	43
2. Analysis.....	46
3. Conclusions.....	53
4. Safety recommendations.....	54
Appendices	
1. Flight Data Recorder read-out.....	55
2. Braking performance analysis.....	60
3. Calculated ground track.....	63

FOREWORD

This report is a technical document that reflects the views of the investigation team on the circumstances that led to the accident.

In accordance with Annex 13 of the Convention on International Civil Aviation, it is not the purpose of aircraft accident investigation to apportion blame or liability. The sole objective of the investigation and the final report is the determination of the causes, and define recommendations in order to prevent future accidents and incidents.

In particular, Article 13 of the Royal Decree of 9 December 1998 stipulates that the safety recommendations made in this report do not constitute any suspicion of guilt or responsibility in the accident.

Unless otherwise indicated, recommendations in this report are addressed to the Regulatory Authorities of the State having responsibility for the matters with which the recommendation is concerned. It is for those Authorities to decide what action is taken.

The investigation was conducted by L. Blendeman, Chief Investigator.

The members of the investigation team were:

NTSB Team

Mr J. Sedor, Senior Air Safety Investigator – Accredited Representative
Representatives of the FAA, Boeing, Pratt and Whitney, Kalitta Air.

AAIU (Belgium) OPS Team:

Cpt D. Poelman
Flt Eng. J. Sonck
Flt Eng F. Van Laerhoven

The NTSB, as representative of the State of Design of the aircraft and State of the Operator, provided support for on-site inspection, the read-out of the FDR, CVR as well as Specialist report in various fields; the following reports were issued:

- Structures Group Chairman's Field Notes
- Powerplant Group Field Notes
- Systems Group Chairman's factual report on investigation.
- Group Chairman's Field Notes – Operation / Human Performance
- Cockpit Voice Recorder 12 – Group Chairman's factual report
- Flight Data Recorder 10 - Group Chairman's factual report
- Maintenance Records specialist Report
- Technical Advisor's report – Operations
- Training record report
- Engine inspection report.

The Boeing Company provided the analysis of the performance of the airplane during the Rejected Take-Off.

NOTE: For the purpose of this report, time will be indicated in UTC, unless otherwise specified.

Synopsis.

Date and hour of the accident.

Sunday, 25 May 2008, at 11.30 UTC (*)

Aircraft

Operator: Kalitta Air LLC.
Aircraft Manufacturer: Boeing Co
Aircraft Model: 747-209F
Aircraft Registration: N704CK
Serial Number: 22299

Accident location

Brussels National Airport (EBBR)

Type of Flight

Cargo transport

Abstract.

The accident was notified to the AAIU (Belgium) at 11:40 on the 25 May 2008. The ATC supervisor at the Tower of Brussels Airport reported the accident by phone.

The investigation was initiated by the AAIU (Belgium) as soon as the investigator-in-charge arrived at the airport crisis center, at 12:40.

The investigation was carried out in accordance with the international Standards and Recommended Practices (SARPs) contained in the ICAO Annex 13 and the Belgian Law.

The USA were involved in the investigation through their accredited representatives and advisers. The NTSB team, supported by advisors from the FAA, the manufacturers Boeing and Pratt & Whitney and from the Operator Kalitta Air llc arrived in Brussels on the 26 May 2008.

On May 25, 2008, at 11:31(UTC), a Kalitta Air B747-200 overran runway 20 of the Brussels Airport, Belgium after a Rejected Take-Off.

The aircraft came to a stop 300m after the end of runway 20, above the railroad embankment.

The aircraft was severely damaged; it broke in 3 parts. The crew of 4, and a passenger have safely evacuated, and suffered only minor injuries.

The cargo aircraft came from JFK International airport, New York and after a technical stop in Brussels, would continue to Bahrain.

The initial phase of the take-off run occurred normally. The speed increased under a constant acceleration until one of the engine experienced a bird strike. This caused a momentary loss of power, accompanied by a loud bang, heard by the crew and external witnesses, and by flames, seen from the control tower.

The bang and the loss of power occurred 4 seconds after the V1 speed call-up.

Two seconds after the bang, all four engines were brought back to idle, and braking action was initiated.

The aircraft reached a first embankment, dropping from a height of 4 m, and broke in three parts. The aircraft came to a stop just above the top of the railroad embankment.

1. Factual Information

1.1. Chronology of the events

The flight crew arrived at Brussels the day before the accident, with a flight from Bahrain. The crew rested until the Sunday morning.

The aircraft arrived at Brussels on Sunday with another crew; the two crews exchanged some information regarding the airplane. There were no mechanical problems reported.

Runway 20 was in service for take-offs, while Runway 25L was mostly used for landings.

The pilot performed the pre-flight inspection; he found only minor discrepancies (left inner tire check and E&E door latch down).

The pre-flight briefing covered the standard departure call-outs, the runway incursion information, a discussion on the Runway 20 length, etc..

The crew also briefed about the engine failure procedures for an engine failure prior to V1, and they also briefed about an abort take-off after V1 if there was a dangerous situation that would not allow the airplane to fly.

After completing the flight documents, the crew requested an early departure, which they received. For the computation of the take-off parameters, the crew used the Kalitta Air On-board Performance System (OPS computer).

The crew determined they needed the full length of the runway for take-off.

The airplane taxied towards the B1 intersection for the Runway 20.

After a few minutes, waiting for another airplane to land on Runway 25, they lined up on Runway 20, making a tight turn, in order to gain a few meters with respect to the usual departure position.

The airplane was cleared for take-off at 11:29.

The pilot pushed the throttles forward and checked the engines were stable. The Flight Engineers then set the engine power for take-off (setting "normal", also known as "reduced thrust").

The aircraft started to accelerate. The standard call-out were made when the speed reached the determined value.

- "airspeed"
- 80 knots
- V1

A few seconds after reaching V1, the engine N³ ingested a bird.

Approximately 5 seconds after V1, the engine N³ stalled and caused a loud "bang", and a vibration felt in the cockpit.

The pilot stated he had the feeling that the aircraft was no longer accelerating, and decided to abort the take-off. Two seconds after having heard the detonation, the thrust levers were brought back to idle, and braking action was initiated. The thrust reversers were not deployed.

The FO called the tower, and notified the aircraft was going to the overrun.

The pilot turned the aircraft a few degrees to the right, in order to avoid the approach lights at the end of the runway.

The aircraft left the runway at a speed of approximately 72 Knots.

The aircraft reached a first embankment, dropping from a height of 4 m, and broke in three parts. The aircraft came to a stop just above the top of the railroad embankment.

The crew exited the airplane through the service door since the L1 door normally used was blocked due to deformation of the structure.



1.2. Injuries to persons.

The crew suffered only minor injuries.

1.3. Damage to aircraft.

The aircraft was totally destroyed.

The airplane fuselage fractured completely at two locations. All of the fracture surfaces exhibited features consistent with static overload with no evidence of metal fatigue.

The wings, horizontal and vertical stabilizers, and all of the moveable control surfaces remained attached to the airplane.

Fuselage Major Fractures

The entire fuselage was right side up at the accident site with severe impact damage and multiple skin, stringer and frame fractures. The fuselage fractured into three sections. The first major fracture of the fuselage – on the RH side – was located at about FS 1100 and the second at FS 2285.

The second section of fuselage, the fuselage skin, stringer, frame pressure deck and overwing longeron structure are raised up approximately 1.5 meter above the wing upper skin panel.





The main keel beam box was fractured just forward of the body landing gear drag brace support fitting. At the fracture, the aft keel beam is lifted up and separated from the forward keel beam.

The aft fuselage fracture was located at the tail section, just in front of the rudder.



Main Cargo Deck.

The main cargo deck portion located in the forward section of the fuselage was fractured and pushed up in the area where the nose gear penetrated the lower lobe of the fuselage.



The most forward cargo pallets (P1 and P2) were no longer secured by the cargo locks.

Doors

The L1 main cabin door, that the crew normally uses to exit the airplane could not be opened. The main deck floor was pushed up about 40 cm just inboard of the door.

All of the remaining cargo doors were in the closed position.

Landing Gear

NLG

The nose gear was collapsed aft and there was no fracture at the primary attachment point or to any of the primary structure that comprises the nose landing gear. The nose gear was pushed up through the fuselage.

MLG

The left wing landing gear separated from the rear spar. The entire gear was pushed up through the upper wing trailing edge panels.

The left body gear remained attached to the aircraft.

The right body gear failed in between the wheels and the gear rotated about the trunion.

The right wing gear separated from the rear spar. The entire gear rotated aft and was located beneath the right wing.

All of the fracture surfaces exhibited features consistent with static overload with no evidences of metal fatigue.

Engines.

The airplane was found resting on engine N°2 and 3 , due to the collapse of the landing gears. The engines were resting on their cowlings, and engine fan N°2 and 3 were seized.

The engines did not show catastrophic failure prior to the final impact.

The thrust reversers were found in the stow position.

1.4. Other damage.

The ILS antennas were damaged, as well as some runway lights and the surrounding fence.

Some of the 85 tons of fuel leaked from the tanks, and sipped into the ground, polluting it. A volume of ground had to be removed and treated.

1.5. Personnel Information.

Captain.

Sex: Male.

Age: 59y.

Nationality: USA.

Licence: ATPL (A) issued on 8 March 2003 (addition of B747 type rating).

Qualifications: B747, B757, B767, DC-8,
No limitation on B747.

Medical Fitness: Medical certificate first class, issued on 20 March 2008.

The captain had accumulated a total experience of about 15000 FH, including 3000 FH in the B747, among which 2500 FH as pilot-in-command and 500 FH as First Officer. He was upgraded to captain on B747 on March 2, 2005.

The captain complied with all relevant requirements as laid down by the US FAA and Kalitta Air. This includes B747 initial, recurrent training (last followed in January 2008), proficiency check (last in February 2008), and line check (last in February 2008).

Flight time.

At the time of the accident, the pilot had:

- not flown in the preceding 24h hours.
- flown 20 hours in the last 7 days
- flown 74 hours in the last 30 days
- flown 268 hours in the last 90 days
- flown 705 hours in the last 12 months.

First Officer.

Sex: Male.

Age: 48y.

Nationality: USA.

Licence: ATPL (A) issued on 4 December 2007.

Qualifications: B747, GE-500, CL-65, SF-340.
Limitations to Second-in-Command for the B747
and CL-65.

Medical Fitness: Medical certificate first class, issued in January
2008.

The first officer had accumulated a total experience of about 7000 FH
among, including 200 FH in the B747.

The first officer complied with all relevant requirements as laid down
by the US FAA and Kalitta Air. This includes B747 initial (November
2007), proficiency check (December 2007), operating experience
checks, and line check (March 2008).

Flight time.

At the time of the accident, the pilot had:

- not flown in the preceding 24h hours.
- flown 13 hours in the last 7 days
- flown 29 hours in the last 30 days
- flown 106 hours in the last 90 days
- flown 200 hours in the last 12 months.

Flight Engineer.

Sex: Male.

Age: 53 y.

Nationality: USA.

Licence: Mechanic A&P issued 8 March 1994.
Flight Engineer, issued on 28 Dec 1992.

Medical Fitness: Medical certificate second class, issued in January
2008.

The flight engineer had accumulated a total experience of about 7000
FH among, including 1950 FH in the B747.

The flight engineer complied with all relevant requirements as laid
down by the US FAA and Kalitta Air. This includes B747 initial,
recurrent (last in February 2008), proficiency check (March 2008) and
line check (December 2007).

Flight time.

At the time of the accident, the pilot had:

- not flown in the preceding 24h hours.
- flown 20 hours in the last 7 days
- flown 31 hours in the last 30 days
- flown 85 hours in the last 90 days
- flown 490 hours in the last 12 months.

1.6. Aircraft information.

The B747 is a 4-jet engine wide body airliner. It first flew on 9 February 1969. A total of 1405 units were produced until now.

The B747 exists in several versions, for the transport of passenger and freight.

The 747-200F is the freighter version of the B747-200 model. It can be fitted with a side cargo door and a nose cargo door. The nose swings up so that pallets or container, in length of 12m can be loaded straight in on motor-driven rollers. It has a freight capacity of 110 tons, a basic operating weight of 340661 lb (154661 kg), a maximum fuel capacity of 161819 kg and an maximum take-off weight of 820000 lb (371945 kg). It entered first service in 1972 with Lufthansa.

A total of 393 of the -200 versions had been built when production ended in 1991. Of these, 225 were 747-200s, 73 were 747-200F, 13 were 747-200C, 78 were 747-200M, and 4 were military.

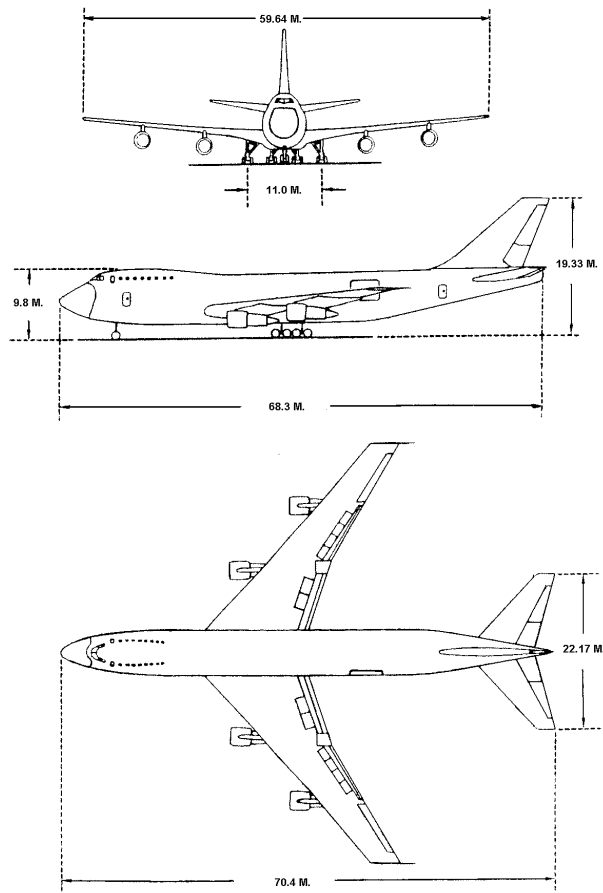

15A General Dimensions: Models B-747-100B, -200, -300

Airframe

Manufacturer: Boeing Co
Type: 747-209F
Serial Number: 22299
Built year: July 1980
Registration: N704CK
Certificate of Registration: issued 10 Sep 2003
Airworthiness: Standard Airworthiness Certificate issued
11 Sep 2003.
Total Flight Hours: 108560.2 FH
Total Flight Cycles: 20599 FC

Engine 1

Manufacturer: Pratt and Whitney
Type: JT9D-7Q
Serial: 702399
Date installed: 21 Oct 2007
Time since Overhaul: 1583.4 FH

Engine 2

Manufacturer: Pratt and Whitney
Type: JT9D-7Q
Serial: 702394
Date installed: 3 Oct 2006
Time since Overhaul: 9584.4 FH

Engine 3

Manufacturer: Pratt and Whitney
Type: JT9D-7Q
Serial: 702119
Date installed: 22 Apr 2008
Time since Overhaul: 250.8 FH

Engine 4

Manufacturer: Pratt and Whitney
Type: JT9D-7Q
Serial: 702082
Date installed: 15 Apr 2008
Time since Overhaul: 289.8 FH

Maintenance

The airplane was maintained in accordance with Kalitta Air LLC maintenance program, as approved by the US FAA on January 3, 2008.

This program includes the following;

- Terminating service, every 7 days,
- A-Checks, divided in 12 segments, every 470 FH
- C-Checks, divided in 12 segments, every 5600 FH or 72 months (wof)
- D-Checks, every 24000 F.

The structural inspections (SSID, CPCP) were performed in accordance with the Boeing documentation.

A Continuing Analysis and Surveillance Program (CAS) is in place at Kalitta Air LLC, in order to endure the adequacy of the maintenance programs and to confirm the programs were properly followed and controlled.

A review of the CAS reports for March and April 2008 did not reveal any chronic issues with the fleet.

There were no open troubles reported on the trouble report log at the time of the accident.

All time-limited components were within their allowable time limits.

All applicable Airworthiness Directives were complied with.

From April 2004 through April 2008, 70 Operational/ Structural Difficulty Reports were reported to the FAA for this airplane. The breakdown is as follows:

- o Structural (46)
- o Pylons (12)
- o Lights (6)
- o Engines (3)
- o Cargo Door (1)
- o Electrical (1)
- o Cargo Smoke (1)

On April 20, 2008 an Engine N°3 Fire warning was reported. As a consequence, the engine was being replaced. All discrepancies to the airplane were rectified.

Aircraft loading.

The loading of the aircraft was performed in accordance with the Kalitta Air, LLC B-747 Weight and Balance Manual.

The loading was retrieved from the wreckage, and weighed at the facility of Flight Care in Brussels Airport. No significant deviation were observed with respect to the Load Sheet.

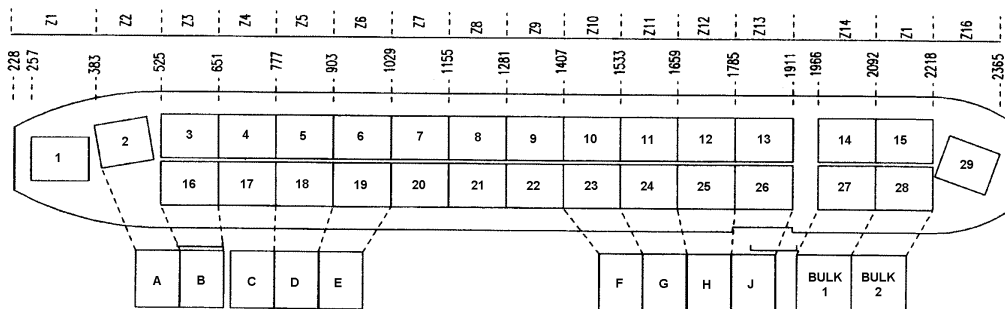

Location	Weight (lb – load sheet)	Weight (kg – load sheet)	Weight (kg – measured)	Difference
1A	370	168	168	0
1	7813	3544	3335	-209
2	3483	1580	1455	-125
3	4665	2117	2050	-67
4	6171	2800	2740	-60
5	5432	2464	2480	16
6	5335	2420	2430	10
7	5353	2429	2425	-4
8	5670	2572	2660	88
9	3413	1549	1535	-14
10	3510	1593	1570	-23
11	2557	1160	1160	0
12	4718	2141	2115	-26
13	8477	3846	3865	19
14	5335	2420	2400	-20
15	5490	2491	2620	129
16	5864	2660	2372,5	-287,5
17	5864	2660	2372,5	-287,5
18	6583	2986	2860	-126
19	8770	3979	4000	21
20	5238	2376	2400	24
21	5137	2331	2235	-96
22	4949	2245	2230	-15
23	4916	2230	2210	-20
24	3880	1760	1785	25
25	3699	1678	1645	-33
26	0	0	0	0

27	2425	1100	1035	-65
28	5375	2439	2445	6
29	3113	1413	1475	62
A	1830	831	800	-31
B	2945	1336	1225	-111
C	1407	639	715	76
D	2297	1042	820	-222
E	2156	978	955	-23
F	0	0	0	0
G	0	0	0	0
H	1711	777	645	-132
J	4802	2179	2025	-154
B1	2755	1250	1250	0
B2	2180	989	1034,56	45,56
Total	165688	75172	73375	-1629

Note: "1A" is located next to pallet 1, and is comprised of on-board equipment. "B1", or "Bulk 1 is the Fly-away kit.

Takeoff parameters

The takeoff parameters were computed with the On-board Performance System (OPS computer). The following data were entered:

- Take-off gross weight of 692830 lb.
- Runway 20; total length of 2987m
- Meteo data as per ATIS S – wind 210°6knots, QNH 10 12.2, runway Wet
- Flaps selection 10 degrees
- Normal take-off (Reduced take-off)

These data gave the following take-off parameters;

V1: 138 knots

Vr: 157 knots

Stop margin: 897 ft (273m)

EPR: 1.447

(max EPR): 1.581

Wind ; 06H/01X

BRU		EBBR		V ₁	138	STOP MARGIN	897	FLAPS	10°
RUNWAY	20	INTXN		V _R	157	3 ENG PITCH	14	LEVEL-OFF (MSL)	984
		TURN	NO	V ₂	167	DUMP TIME	16 MIN		
NOTE									
ATIS	(S)	WIND	210/06	TEMP	19	QNH	1012		
WIND COMP	6H/01X	PRESS ALT	218	SELECT	10°	X		REDUCED EPR	1.455
ASSUM TEMP	44	STAB	6.7	M	5°	207		MAXIMUM EPR	1.585
		C.G.	18.3%		1°	227		NOMINAL N1	100.6
ACTUAL TOGW	692830	CONDITIONAL MAX TOGW	695380		0°	247		MAX CLMB EPR	1.356
		RUNWY						GO ARND EPR	1.527
PACKS	OFF	ANTI-ICE	OFF						

1.7. Meteorological Information.

Meteo Report.

The crew made the computation of take-off parameters with the ATIS S data:

Wind Direction: 210 Degrees Variable between 160° and 250°
 Wind Speed: 6 Knots
 Visibility: 10KM
 Cloud: scattered at 2400FT Broken at 3500FT
 Temperature: 19 °C
 Dew Point: 15 °C
 QNH: 1012.2 hPa
 Validity: 10:39 – 10:51

The recorded message, available to the crew before the push-back, stated:

Brussels National Departure Tango 1050
 Runway 20 for departures, wet
 Runway 25L and 25R for arrivals
 Transition level 55
 Wind: 230 degrees
 Wind speed: 5 knots
 Visibility: 10 km or more
 Clouds: Scattered at 1900 ft, broken at 4000 ft
 Temperature: 19 °C

Dew Point: 14 °C
QNH: 1012
Validity: 10:51 – 11:21

Upon Take-off (at 11:30), the conditions were:

Brussels National Departure Uniform 1120
Runway 20 for departures, wet
Runway 25L and 25R for arrivals
Transition level 55
Wind: 240 degrees variable between 190 and 320 degrees
Wind speed: 2 knots
Visibility: 10 km or more
Clouds: Scattered at 2000 ft, broken at 4000 ft
Temperature: 19 °C
Dew Point: 14 °C
QNH: 1012
Validity: 11:21 – 11:37

1.8. Aids to Navigation.

Not applicable.

1.9. Communication.

Radar trace

The path of the airplane has been recorded from the ground radar data of Brussels airport. The radar image results from the integration of the data of 4 radars located at various places on Brussels Airport (Cardion, North, South, Tower).

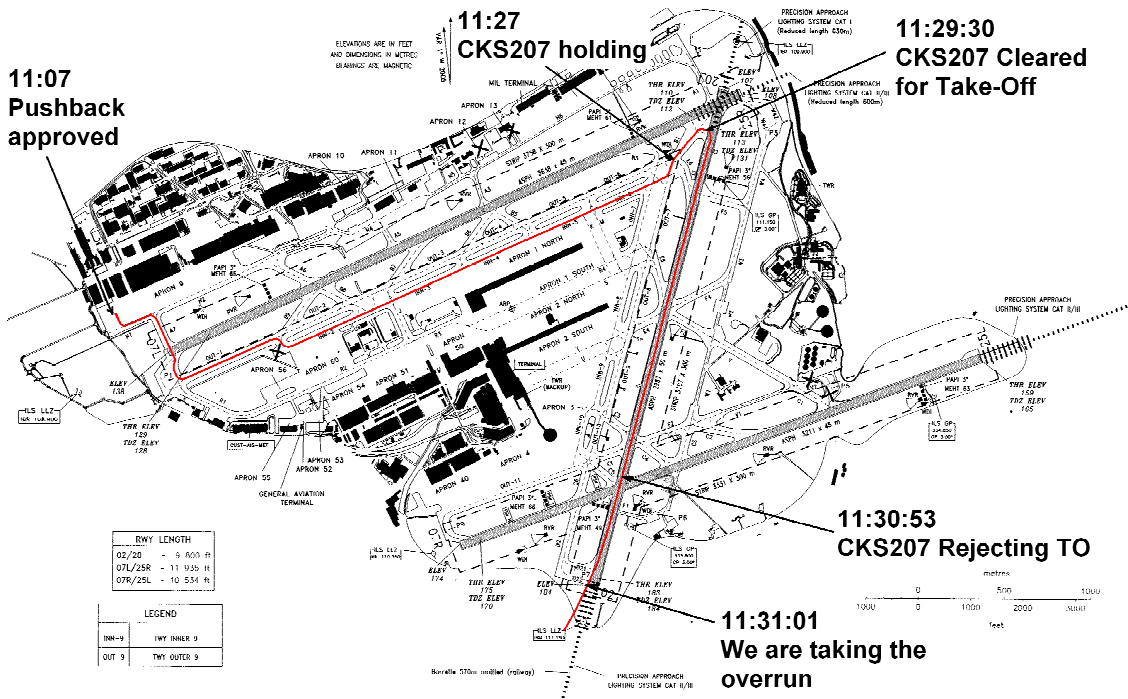

Ground radar image of CKS207 lining up on R20.

Communication with ATC

The airplane successively contacted the following frequencies;

- ATIS on 121.75 MHz
- Delivery on 121.95 MHz
- Departure on 126.625 MHz
- Ground on 118.050MHz
- Tower on 120.775 MHz

The relevant communication is hereunder.

ATIS

See chapter 1.7 hereabove.

Delivery Frequency

The crew got ready ahead of schedule – the slot time was 11:44 - and a request was made for an early departure.

Brussels Delivery notified CKS207 that the request was granted, and a new slot time was set at 11:24.

At 11:05:34 Brussels Delivery called CKS207:

“Connie two zero seven startup approved in accordance to your slot cleared to Bahrain via the SOPOK two Lima departure routing runway two zero squawk zero one zero five”.

Ground Frequency

The crew contacted the ground frequency to get the clearance for pushback, which was approved on 11:06:54.

At 11:13:34 CKS207 contacted Brussels Ground.

11:13:34	CKS 207	Brussels Ground, Connie two zero seven, heavy, taxi with Tango
11:13:37	GND	Connie two zero seven, taxi alfa seven, hold short runway two five right, QNH one zero one two.
11:13:46	CKS207	Alfa seven, short of two five right, Connie two zero seven

Tower Frequency

The crew then contacted the Tower frequency to approval to cross runway 25R.

Ground Frequency

After having crossed the runway 25R, the crew was requested to switch to the Ground Frequency for further instructions for taxi.

11:17:05	CKS207	Brussels Ground, Connie two zero seven, heavy, outer one.
11:17:10	GND	Connie two zero seven, after outer one, switch over to the inners and then all the way via the inners to bravo one, holding point runway two zero.

The airplane taxied, as requested, and finally contacted the Tower frequency for take-off clearance.

Tower Frequency

The airplane taxied, as requested, and was finally contacted by the Tower frequency.

11:26:04	TWR	Connie two zero seven ?
11:26:10	CKS207	Brussels Tower, Connie two zero seven heavy, we'll be ready for two zero
11:26:14	TWR	Connie two zero seven, are you able to line up and take position clear of runway two five right ?
11:26:22	CKS207	Negative
11:26:23	TWR	Roger, hold short runway two zero
11:26:24	CKS207	Hold short runway two zero, Connie two zero seven
11:27:13	TWR	Connie two zero seven, you have the seven four seven, four miles final two five right in sight ?
11:27:17	CKS207	Affirmative, Sir
11:27:19	TWR	Connie two zero seven? behind the landing seven four seven, line up and wait runway two zero, behind
11:27:24	CKS207	Line up and wait runway two zero behind Korean Air, Connie two zero seven.
11:27:30	TWR	That is correct, and to expedite, please, the next traffic is seven miles behind.
11:27:35	CKS207	Roger
11:29:22	TWR	Connie two zero seven, two two zero degrees, four knots, runway two zero, cleared for take-off.
11:29:26	CKS207	Cleared for take-off, runway two zero, Connie two zero seven.

The airplane lines up, check engine power, then initiates the take-off roll.

11:30:51	CKS207	Tower, Connie eight zero seven heavy, .. two zero seven, rejecting runway two zero.
11:30:55	TWR	Connie two zero seven, roger, can you vacate to the right ?
11:30:59	CKS207	Negative... We're taking the overrun.

TWR calls CKS207, but there is no answer.

The Tower supervisor calls the Fire Brigade at 11:31:04. The crash bell is actionned at 11:31:30.

The Tower supervisor further notifies the airport inspection department.

The fire trucks are moving towards the crashed airplane.

11:32:43	Fire 480	Fire four eight zero, alfa three, request to cross runway two five right
11:32:49	TWR	Fire Brigade enter runway two zero and cleared to cross two five right, you can cross two five right, no problem.
11:32:55	Fire 480	Crossing runway two five right, Fire four eight zero

1.10. Aerodrome Information.

General

The Brussels airport is located at 6.5 Nautical Miles (12km) NE of the city of Brussels, on the coordinates 50°54'05"N 004°29'04 "E. The elevation is 56m asl.

The airport is certified (Interim certificate N°A- POR\2008\Annex14_001) to be compliant with the requirements of ICAO Annex 14 and the Belgian Law (AR/KB 15 March 1954).

The airport has three bi-directional runways with hardened asphalt and anti-slip layer (type Possehl). All three runways are certified to ICAO reference code "4E" (this code interrelates the numerous specifications concerning the characteristics of aerodromes, including the length of runways and the size of aircraft it can accommodate).

The B747-200F requires a code "4E" airport.

In accordance with the Preferential Runway System (AIP Part 3 – EBBR AD 2.20 Chap 4.2), runway 25 R was in use for landings, and runway 20 was in use for take-offs, runway 07R/25L was undergoing repairs, and therefore unavailable.

The main characteristics of the runways are:

	02 / 20	07 L / 25 R	07 R / 25 L
Actual bearing	14.43° / 194.43°	65.38° / 245.38°	69 .89° / 249.89°
Available distance for take-off	2987m	3638m	2891m / 3211m
width	50m	45m	45m
Slope	- 0.78% / + 0.78%	- 0.21% / + 0.21%	-0.15% / +0.15%

AERODROME GROUND
MOVEMENT CHART - ICAO

TWR
BRUSSELS TOWER
118.800 125.775

GROUND
BRUSSELS GROUND
121.675 118.050

CLR
BRUSSELS DELIVERY
121.850

BRUSSELS/Brussels-National
BELGIUM

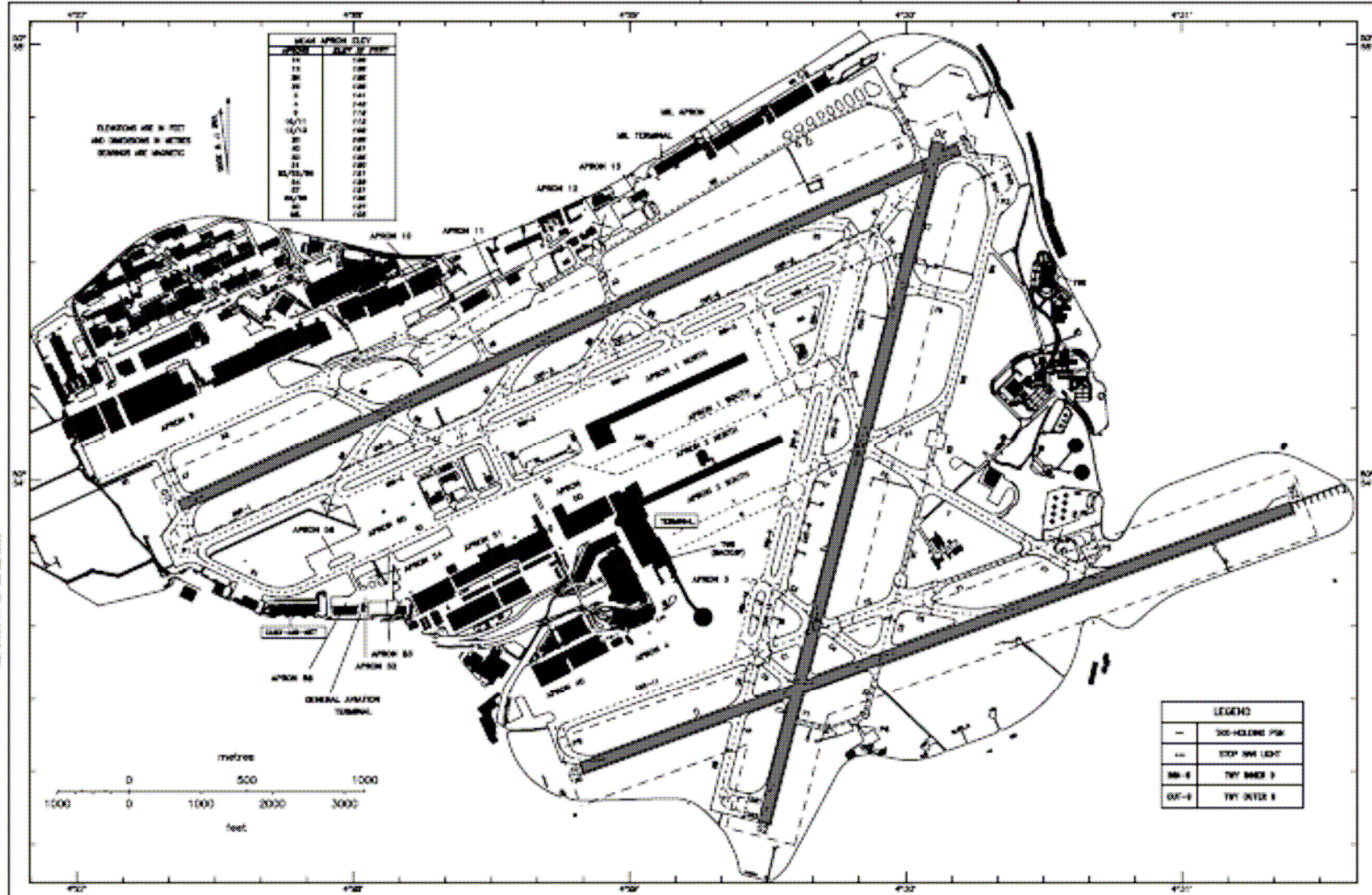

Runway 20 dimensions

a. Length

The available distance for take-off on runway 20 with the intermediate line-up positions are:

Runway 20	Line-up position	Available distance for TO
	Full length	2987m
	B1	2675m
	E6	2164m
	E5	1558m
	E4	1558m

As per F.A.R. Take-off runway length graph hereunder, runway 20 can accommodate a B747-200F up to a take-off weight of 800000 lb, in standard conditions (note: N704CK had a TO gross weight of 690215 lb).

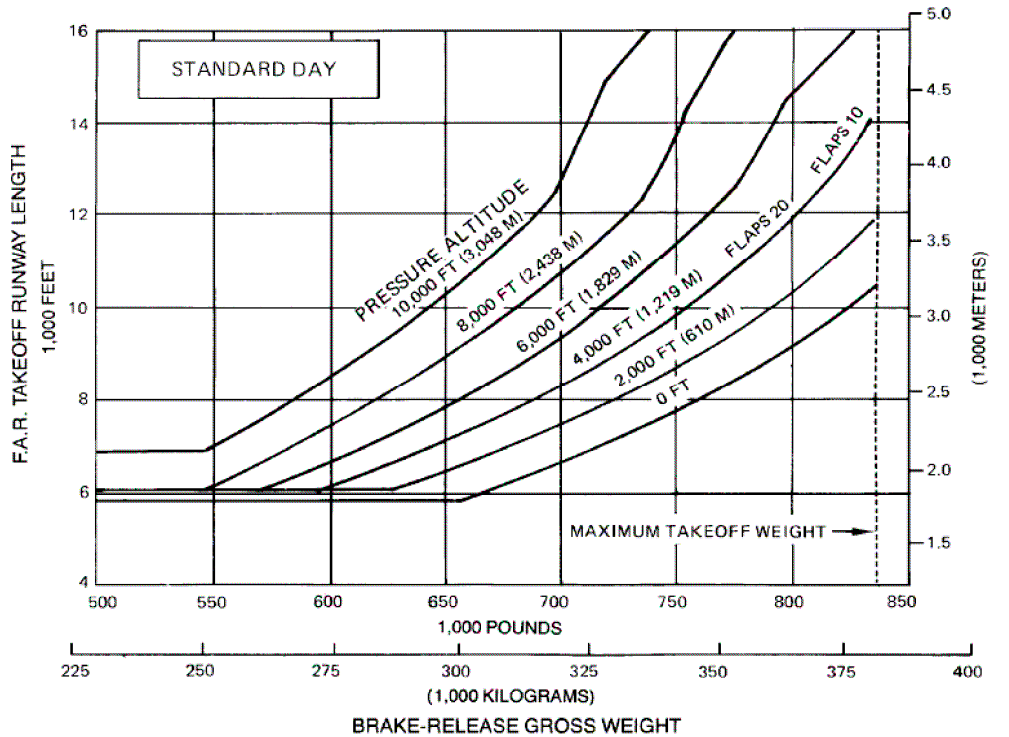

F.A.R Take-off runway length for B747-200 with JT9D-7Q engines

Note:

Nevertheless, the use of a longer runway (such as 25R) is always possible. As per AIP Part 3 – EBBR AD 2.20 Chap 4.1 , the pilot-in-command needs to request authorization to ATC. The request will be accepted, provided that traffic and air safety conditions permit.

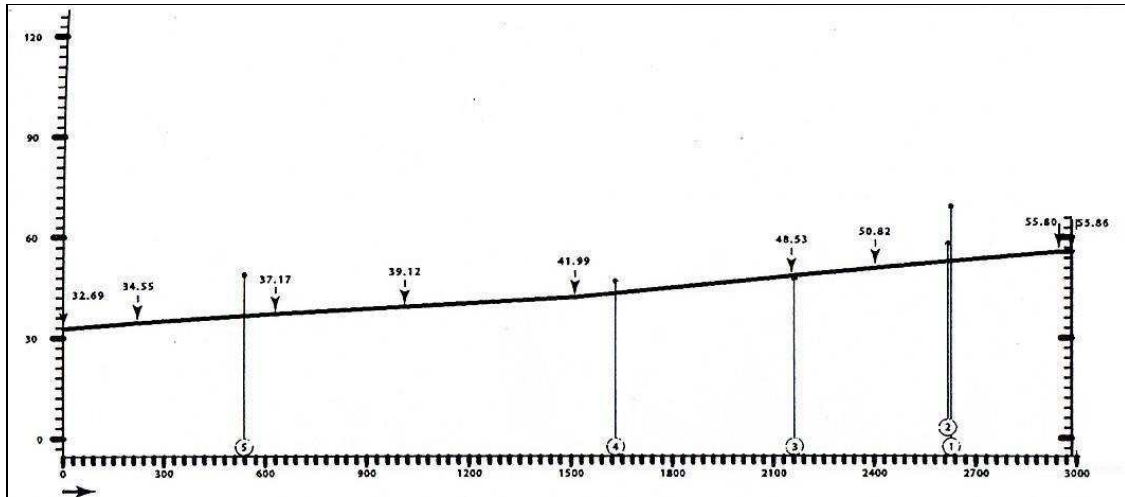
b. Slope.**Runway 20 - slope**

The slope on runway 20 is on average +0.78%; but from 0 to 1500m, the runway has a slope of 0.62, then for the remaining 1487m, it has an increased slope of 0.93%. Both values are complying with the ICAO recommended limits.

Friction Factor

The friction factor of runway 20 was measured in April 2008, after cleaning (rubber removal). The friction factor was again measured after the accident. It shows a slight degradation, but the values are still indicating a 'good' level of friction on the whole length of runway 20.

The measurement are made on the left and on the right side of the runway.

Zone	Left side April 08	Left side June 08	Right side April 08	Right side June 08
Front	0.8	0.76	0.86	0.72
Middle	0.72	0.66	0.71	0.65
End	0.82	0.79	0.86	0.79
Average	0.78	0.74	0.81	0.72

The touch-down zone of runway 02 is located in the 'End' zone of runway 20.

The expected friction value after cleaning is above 0.74; the limit value under which a cleaning of the runway is required is 0.47.

A cleaning of the runway, in particular the touch-down zone of runway 02 was planned for end September 2008.

RESA.

The **Runway end safety area (RESA)** is an area extending beyond the ends of a runway strip, capable of adequately supporting an aircraft which overruns or undershoots the runway.

This area needs to be clear of all equipment and installations which are not frangible.

The RESA of runway 20 complies with the requirements of ICAO Annex 14 (min length of 90m, min width of 90m).



However, the same ICAO Annex 14 recommends to extend the length of the RESA to a distance of at least 240m. This recommendation (not mandatory) is not met for runway 20.

The runway is bordered by a road located 4m lower than the runway. The railroad tracks of the line Brussels – Leuven is 50 m further back, 20m lower than the ring road level.

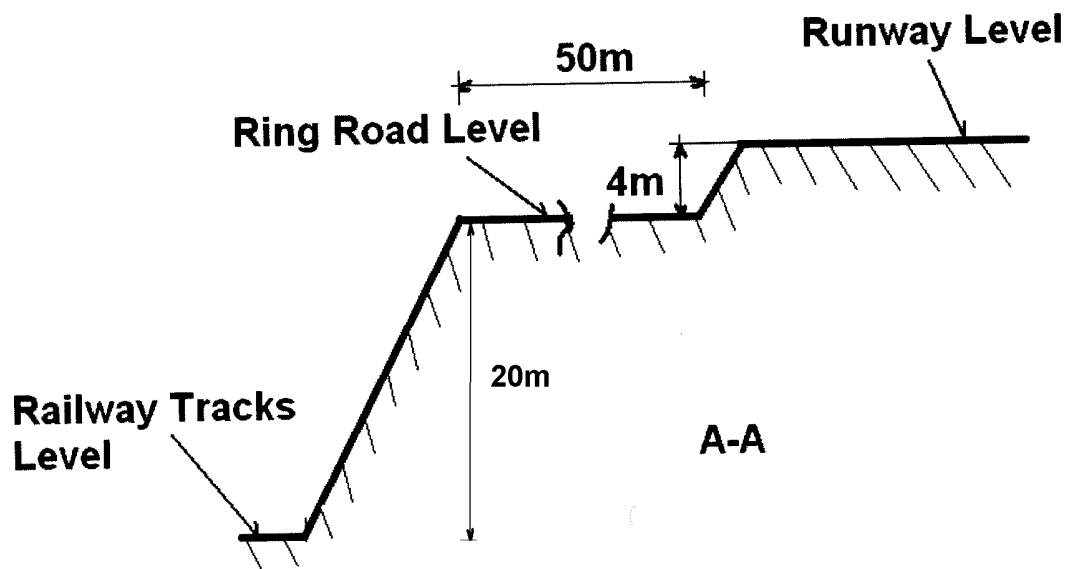
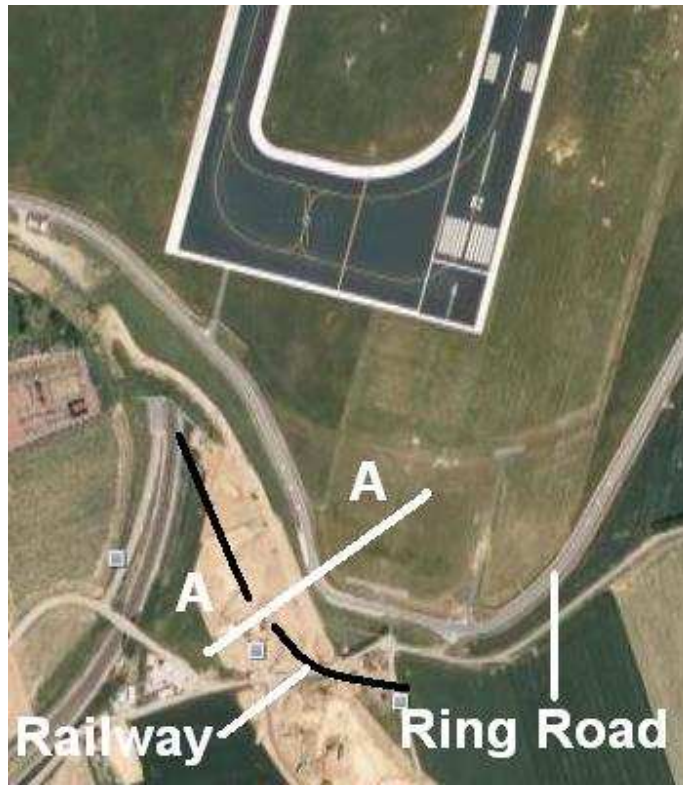



The extension of the RESA seems difficult due to the presence of the railroad tracks, in the direction of R20 and roads in the opposite direction. The extension would involve serious costs.

A possibility to increase the efficiency of the RESA is to install an **Engineered Material Arrestor System (EMAS)** in order to create an additional braking effect.

EMAS consists of a bed of cellular cement, designed to crush under the weight of an aircraft.

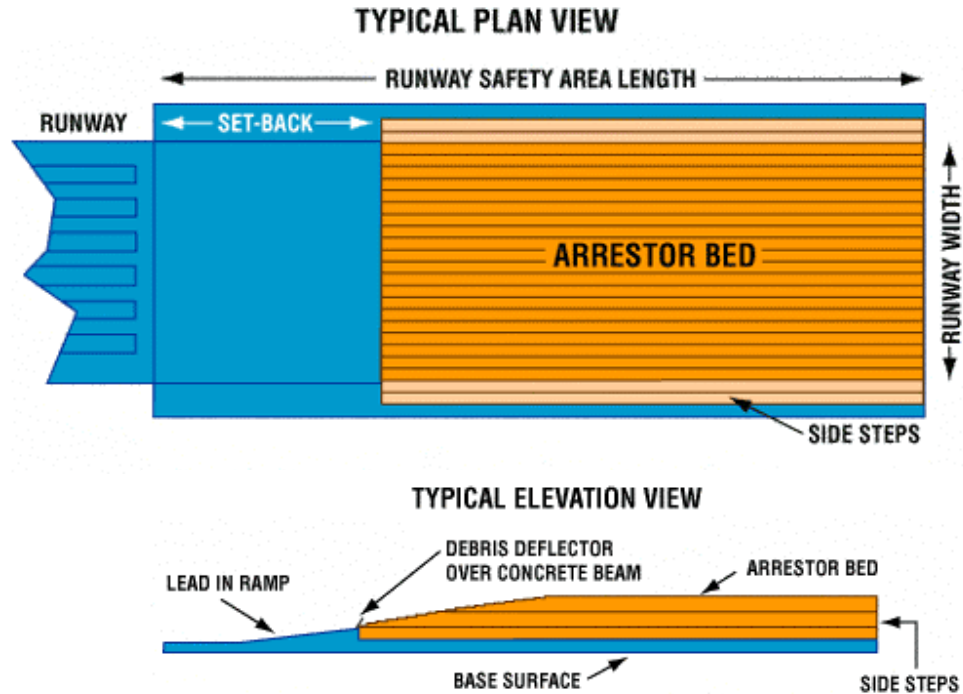

The system is approved by the FAA (AC-150/5220-22A)

It was first installed in 1996. There are currently 41 installed in the world to date (Madrid, Sichuan, LGA, JFK,..).

Computation showed that N704CK, **if it had not deviated to the right** would have stopped before the first ditch, in the case runway 20 was equipped with an EMAS RESA.

Bird Control.

Brussels airport has a bird control unit of 6 people, including a team leader, member of the airport inspection.

The actions are as follows;

- bird strike reporting,
 - bird strike reports analysis,
- and on a daily base, actions leading to reduce the risk, such as
- dispersal by distress signals,
 - dispersal by pyrotechnic bird scaring cartridge,
 - dispersal by lethal methods.
 - grass length management.

Dispersal by lethal methods is not allowed for protected bird species, such as the eurAsian kestrel, falcons, owls, buzzard, and is further submitted to the legal requirements for game hunting.

The activity report of 25 May shows some bird activity in the vicinity of runway 20 (crows and pigeons).

On average, there are 100 Bird strikes recorded per year at Brussels Airport, reported by either crews or through inspection of the runway.

1.11. Flight Recorders.

The aircraft was equipped with

- a Cockpit Voice Recorder
 - o Manufacturer: Fairchild
 - o Part Number: 93-A100-80
 - o Serial Number: 26103
- and
- a Model UFDR Digital Flight Data Recorder.
 - o Manufacturer: Honeywell
 - o Part Number: 980-4100-DXUS
 - o Serial Number: 10908

The two recorders were retrieved from aircraft on 26 May 2008, and sent for read-out to the NTSB on the 27 May 2008.

CVR Cockpit Voice Recorder

The tape cockpit voice recorder was sent to the National Transport Safety Board's Audio Laboratory for read-out.

A group of specialists from NTSB, FAA, Boeing and Kalitta Air on May 29, 2008 and a full transcript was prepared for the 30-minutes, 51 seconds recording.

This model of CVR records 30 minutes of analog audio on a continuous loop tape in a four channel format: one channel for each flight crew and one channel for the cockpit area microphone.

The timing of the CVR was correlated to the flight data recorder (FDR), and both recordings were correlated to the UTC time recorded on the ATC communication system.

The excellent quality recording begin at 13:00:27. The recording contains events from approximately five minutes prior to engine start through the accident sequence. The recording ended shortly thereafter at 13:31:18.

A selection of the transcript is given hereunder;

Time	Microphone	Transcript
11:30:02	ambient	[sound similar to increasing engine rpm]
11:30:05	Captain	airborne at thirty set reduced thrust.
11:30:19	F/O	airspeed.
11:30:20	Captain	checked.
11:30:21	F/E	reduced thrust set.
11:30:25	F/O	eighty knots.
11:30:26	Captain	checked.
11:30:41	F/O	V one.
11:30:46	ambient	[sound of bang]
11:30:46	F/E	whoa.
11:30:47	ambient	[sound similar to throttle quadrant hitting stops]
11:30:48	ambient	[sound of decreasing engine thrust]
11:30:48	Captain	reject.
11:30:51	F/O radio	tower Connie eight zero seven heavy-- two zero seven re-- re-- rejecting runway two zero.
11:30:55	TWR	Connie two zero seven roger can you vacate to the right?
11:30:58	Captain	negative.
11:30:59	F/O radio	negative.
11:30:59	F/E	negative negative negative
11:31:00	Captain	we're gonna take the overrun.
11:31:01	F/O radio	we're taking the overrun.
11:31:02	TWR	roger.
11:31:04	ambient	[sound of impact and metallic grinding noise that continues until the end of recording]

A spectral analysis was also performed on the sound of the bang.

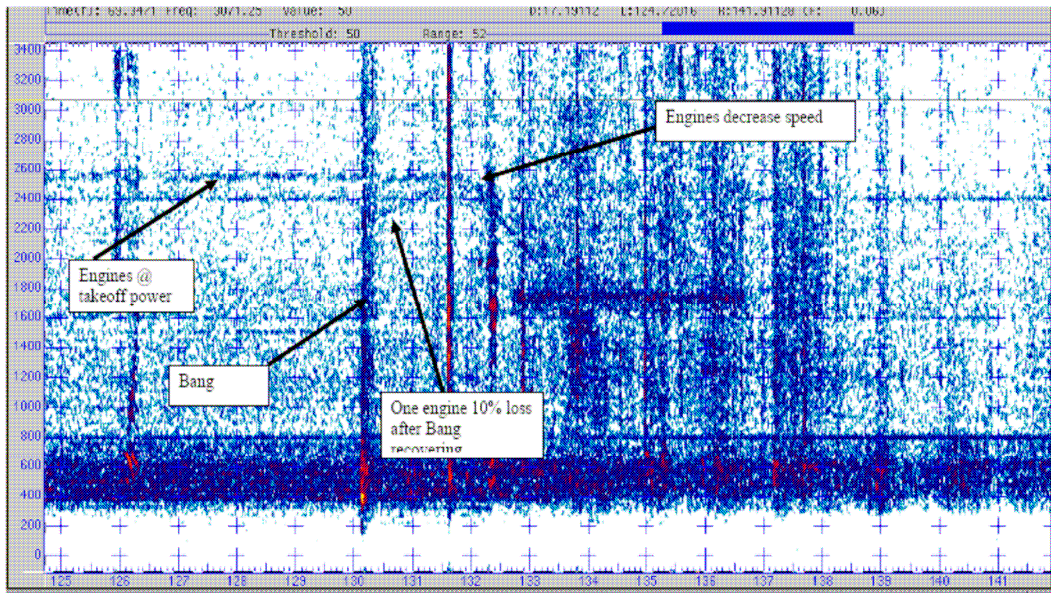

The analysis shows engine operating at take off power, then one (or more) is experiencing a loss of power, followed by a saturation (bang). The sound frequency is then moving to its original value, showing that the involved engine(s) is recovering, until the moment the power is reduced, by the pilot.

UFDR Digital Flight Data Recorder

The Honeywell Universal Flight Data Recorder (UFDR) records airplane flight information in a binary format, using analog signals, onto eight tracks of 1/4-inch Mylar tape. A minimum of 25 hours of flight data is recorded by erasing the oldest data and replacing it with the newest.

The FDR recording contained approximately 25 hours of data. The accident flight was the last flight of the recording and its duration was approximately 19 minutes from the start of the accident recording session to the end of the data.

The US Federal Regulation requires that Commercial Air Transport aircraft are equipped with a Flight Data Recorder. Specifically, the accident aircraft, N704CK, was operating such that it was required to be equipped with an FDR that recorded 22 parameters, as cited in 14 CFR 121.344(c). The accident aircraft was not in compliance with the federal FDR carriage requirements because the sampling interval of the engine power ratio parameters recorded to satisfy the requirements for parameter 9, Thrust/power on each engine, was 4 seconds not the required 1 second interval. Additionally, the installed configuration of the FDR system did not match the documentation provided by the operator and an FDR group was required to determine the correct configuration and conversion information for the accident aircraft.

The FDR group convened on 4-5 Jun 08 at NTSB Headquarters in Washington DC and consisted of members from Boeing, Pratt & Whitney, Kalitta Air, and the FAA. The available documentation was reviewed and the group determined the correct location and conversion algorithms for the parameters recorded on the FDR and cross-checked it against data from a previous flight for validity.

The preliminary results of the read-out were transmitted to AAIU (be) on the 6th June 2008, the final report was issued on January 23, 2009.

The following parameters are recorded:

Parameter Name	Plot/Tabular Label	Units	Record rate
Lateral Acceleration	Accel Lat	g's	
Longitudinal Acceleration	Accel Long	g's	4 per second
Vertical Acceleration	Accel Vert	g's	8 per second
Left Inboard Aileron Position	Aileron-LIB	degrees	2 per second
Left Outboard Aileron Position	Aileron-LOB	degrees	1 per second
Right Outboard Aileron Position	Aileron-ROB	degrees	1 per second
Computed Airspeed	Comp	knots	1 per second
Coarse Pressure Altitude	Altitude Coarse	feet	
Fine Pressure Altitude	Altitude Fine	feet	
Pressure Altitude	Altitude Press	feet	
Autopilot B Command Mode	AP-B Command		
Autopilot B Manual Mode	AP-B Manual		
Control Column Position	Ctrl Col Pos	degrees	2 per second

Control Wheel Position	Ctrl Whl Pos	degrees	2 per second
Left Elevator Position	Elevator-L	degrees	1 per second
Right Elevator Position	Elevator-R	degrees	1 per second
Engine 1 Pressure Ratio	Eng1 EPR		1 per 4 seconds
Engine 1 Thrust Reversers Deployed	Eng1 TR Deployed		1 per 4 seconds
Engine 1 Thrust Reversers In Transit	Eng1 TR In Transit		1 per second
Engine 2 Pressure Ratio	Eng2 EPR		1 per 4 seconds
Engine 2 Thrust Reversers Deployed	Eng2 TR Deployed		1 per 4 seconds
Engine 2 Thrust Reversers In Transit	Eng2 TR In Transit		1 per second
Engine 3 Pressure Ratio	Eng3 EPR		1 per 4 seconds
Engine 3 Thrust Reversers Deployed	Eng3 TR Deployed		1 per 4 seconds
Engine 3 Thrust Reversers In Transit	Eng3 TR In Transit		1 per second
Engine 4 Pressure Ratio	Eng4 EPR		1 per 4 seconds
Engine 4 Thrust Reversers Deployed	Eng4 TR Deployed		1 per 4 seconds
Engine 4 Thrust Reversers In Transit	Eng4 TR In Transit		1 per second
Magnetic Heading	Heading Mag	degrees	1 per second
Leading Edge Flaps L1 Extended	LE Flaps Ext-L1		1 per 2 seconds
Leading Edge Flaps L2 Extended	LE Flaps Ext-L2		1 per 2 seconds
Leading Edge Flaps R1 Extended	LE Flaps Ext-R1		1 per 2 seconds
Leading Edge Flaps R3 Extended	LE Flaps Ext-R3		1 per 2 seconds
Leading Edge Flaps Master In Transit	LE Flaps Master In Trans		1 per second
Pitch Attitude	Pitch	degrees	1 per second
Roll Attitude	Roll	degrees	1 per second
Rudder Pedal Position	Rudder Pedal Pos	degrees	2 per second
Lower Rudder Position	Rudder-L	degrees	1 per second
Upper Rudder Position	Rudder-U	degrees	1 per second
Stabilizer Position	Stab Pos	degrees	1 per 2 seconds

The radar and FDR data were compiled, along with ground marks, and other evidences and analyzed. The ground track, calculated by Boeing is in appendix 3.

The FDR data show the airplane taxiing onto runway 20 in Figure 1 at time 54235 seconds. Seven seconds later the engine pressure ratio begins increasing to takeoff thrust. At time 54286.5 seconds the aircraft reaches V1 (V1 = 138 knots). Four seconds later the right inboard engine shows a 0.1 EPR reduction. Within one second of the EPR reduction, longitudinal acceleration decreases and at time 54292.5 seconds EPR decreases for the remaining three engines. The decrease in longitudinal acceleration is the first indication of a Refused Take Off (RTO) in the data and occurs at an airspeed of 150 knots (V1 + 12 knots). At time 54294 seconds deceleration levels off at -0.28 g's for just over one second before increasing to the maximum deceleration recorded during the RTO of -0.38 g's. At the time of the maximum longitudinal deceleration a spike in lateral acceleration occurs to the right, see figure 2. The lateral movement changes the heading of the aircraft, allowing it to exit the runway off to the right side in order to avoid obstacles. Since there were no significant rudder movements at this point and the nose gear tires showed no sign of being turned, the lateral acceleration spike (and resultant heading change) was most likely the result of differential braking.

The airplane departed the runway at time 54307 seconds with airspeed of 72 knots. The increase in normal load factor variability correlates to the ground track distance data. the end of useable data most likely marks the final impact of the airplane on the lower edge of the embankment.

Among others, the data analysis revealed that the thrust reversers were not deployed.

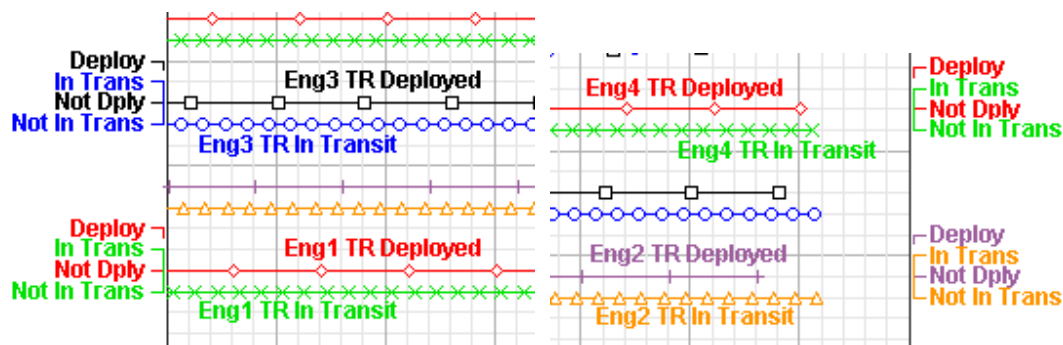

The deceleration is shown hereunder:

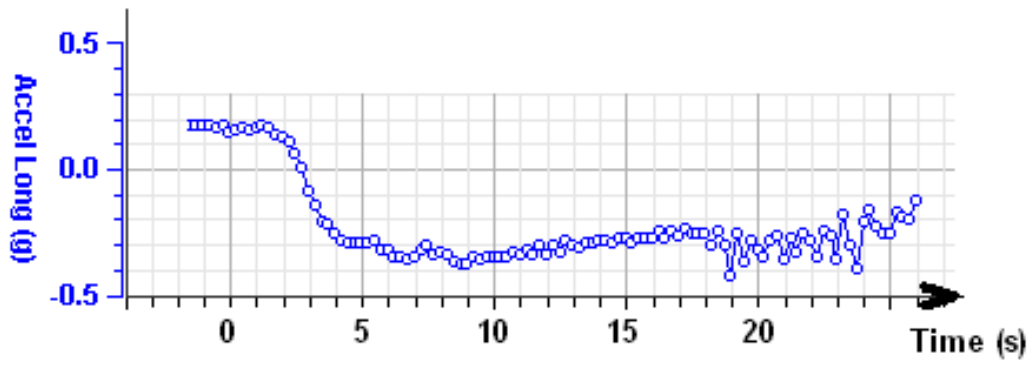

The speed variation:

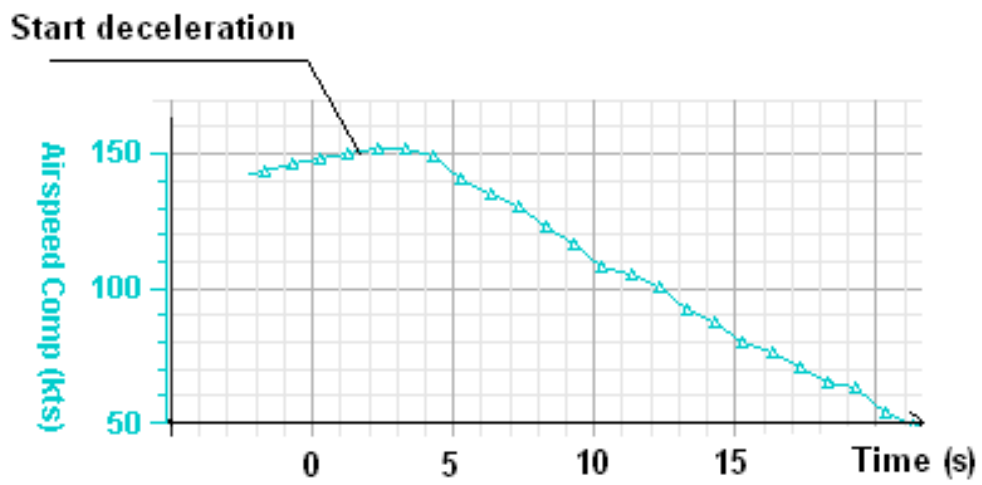

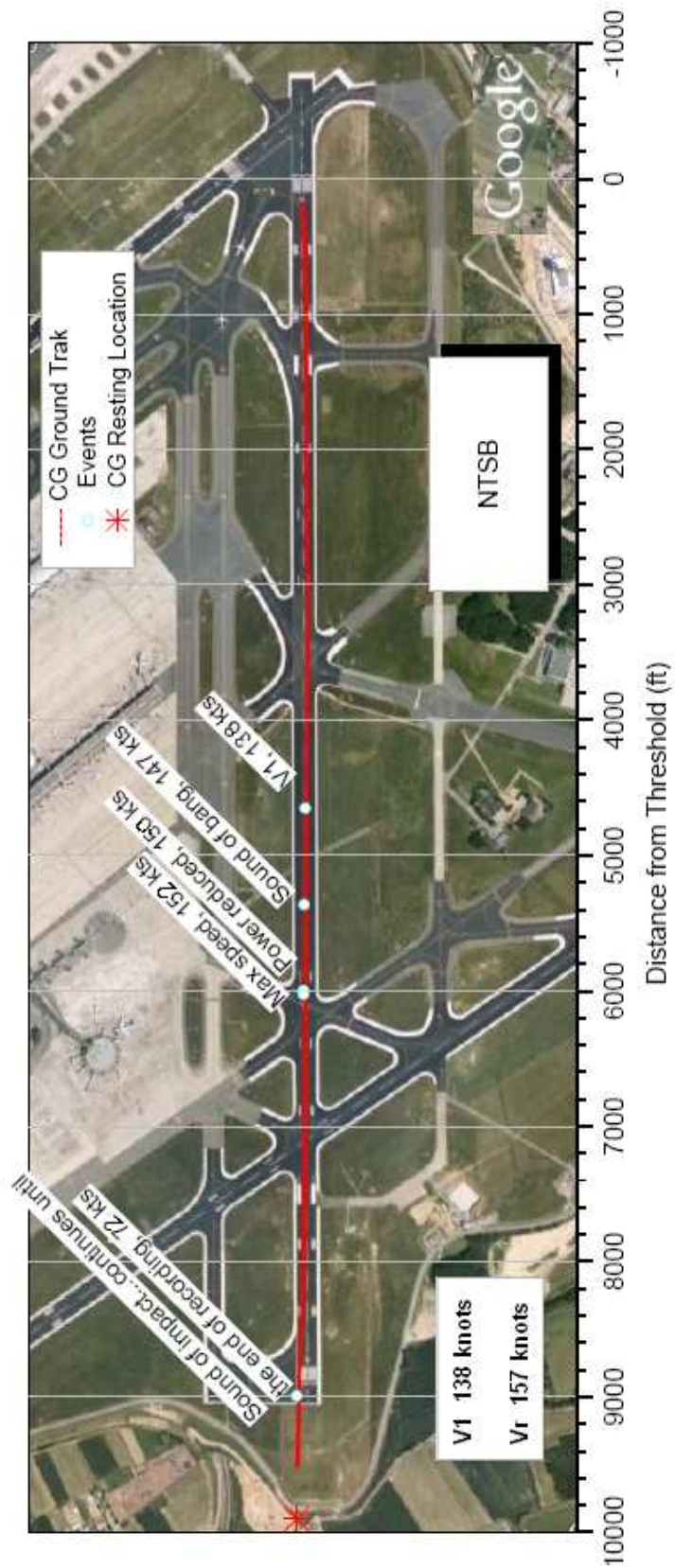

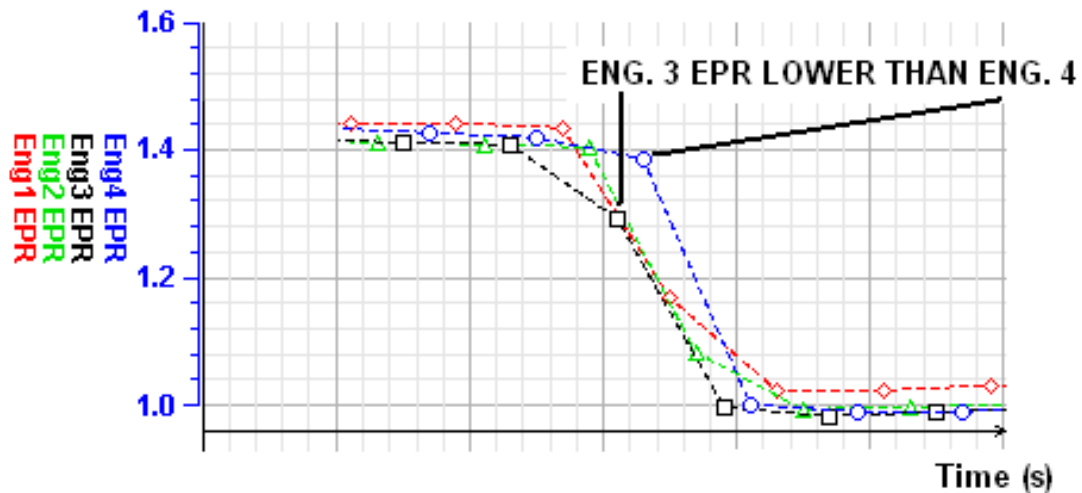

The FDR gives the evolution of Engine Pressure Ratio (EPR) – delivered engine thrust – per unit of time.

As outlined hereabove, the EPR parameter is taken once every 4 seconds for a given engine, and sequentially each second for each different engine. In the graph hereabove, the sequence is engine Nr2 (green triangle) then Nr3 (black block), then Nr4 (blue circle), and finally Nr1 (red losange).

On the third cycle, engine Nr2 and Nr4 are on the same line, while the black block of engine Nr3 is 2 units lower. This is the indication that engine Nr 3 did experience the loss of power, as shown on the sound spectral analysis.

The value of the parameters, after that are consistent with the power reduction, as commanded by the pilot.

1.12. Wreckage and impact information.

The airplane departed the end of runway 20 and traveled 225m in a field before dropping 4m over an embankment to its final resting place. All of the aircraft structure was located at the main impact site. The main wreckage site (nose of the airplane) was located at N 50 53.072 and E 004 23.39 (WGS84).

1.13. Medical and pathological information.

Not applicable

1.14. Fire.

There was no evidence of a post crash fire in the area of the main wreckage site. No evidence or any pattern like those typically associated with a moving/ in-flight fire was identified. No soot pattern was identified. No melted or splattered aluminum was observed on any of the structures.

1.15. Survival Aspects.

The crew reported that they attempted to evacuate via the L1 main cabin door because there was no smoke and due to the distance to the ground from the crew service door.

The L1 door could only partially be opened; the main deck floor was pushed up about 30 to 50cm just inboard of the L1 door making contact with the inside lower edge of the L1 door. There was no emergency evacuation slide at the L1 door location, nor was it required to.

The crew service door on the right hand side of the fuselage was opened and the emergency evacuation slide was deployed. The crew evacuated the airplane through that door, giving access to the railroad embankment. It was close to a free fall.

All of the remaining cargo doors were in the closed position.

Emergency Response.

The Tower supervisor called the Fire Brigade at 11:31:04. The crash bell was actioned at 11:31:30.

The Fire Brigade of Brussels Airport arrived at the aircraft within the prescribed 3 minutes.

The Fire Brigade of Zaventem came a few minutes later. Upon arrival, they scanned the wreckage with thermal cameras. They noticed that Engine 3 was slightly hotter than the other engines.

The Air Support team of the Federal Police flew over the wreckage with thermal cameras in order to support the Fire Brigade. They noticed the right engines appeared hotter than the left engines.

1.16. Test and Research.

Inspection of the Engines

A group comprised of persons from the National Transport Safety Board, the FAA, P&W, Kalitta Air and the Air Accident Investigation Unit (Belgium), convened at the Kalitta Air engine facility in Oscoda, MI on June 23, 2008 to start the disassembly and examination of Engine Nr 3 - JT9D-7Q, SN 702119. Engine Nr4 was also inspected, but to a lesser extent. The examination was completed on June 25, 2008.

Visual Inspection of Engine Nr3

No impact marks or inward deformation of the front or rear spinners were noted. Fan blades Nos. 11, 35, 38 and 42 (86°, 273°, 297° and 328° respectively from index mark) exhibited soft body deformation with the leading edge pushed from the concave towards the convex side. The soft body damage was centered about 3-inches outboard from the platform. No impact marks or inward deformation of the fan exit fairing were noted.

The nine sound absorbing inner rear liner segments were removed from the engine and debris was removed from the inboard side of each screen and individually bagged. The bleed valve assembly was found in the open position (this should be the default position on engine shutdown). A large amount of debris (soil, vegetations, rocks, etc) was found at the 6:00 o'clock position of the fan case as well as in the bottom of the bleed valve linkage support. Centered around the 9:00 o'clock position (aft looking forward), a concentration of the organic material was stuck to the outside of the bleed linkage support, with the rest of the support exhibiting very little.

Organic debris was gathered from all nine sound absorbing inner rear liner segments, from each stage of the LPC stages, from fan blades 8, 9, 10, 19 and 20 and from bleed valve linkage support.



Black Light Inspection of Engine Nr3

The fan blades were inspected using a black light with the blades still installed in the fan disk. A **heavy and concentrated** organic smear and splatter in the axial direction on the concave side of the fan airfoils was observed at the platform between blades Nos. 31 & 32 and 32 & 33 (convex side) (242° from index mark). Blades No. 42 and 43 (329° from index mark) exhibited a light and more spread out organic smear and splatter on the airfoil concave with the smear flowing towards the blade tips. The blade numbering used are the blade numbers used during the initial installation and they sequentially increase clockwise forward looking aft.

Organic speckled material with no directional orientation was noted on the fan exit fairing around the 6:00 o'clock position. A black light inspection of the stage 1.5 low pressure blades revealed an organic smear of 6 consecutive blades on the concave side (pressure).

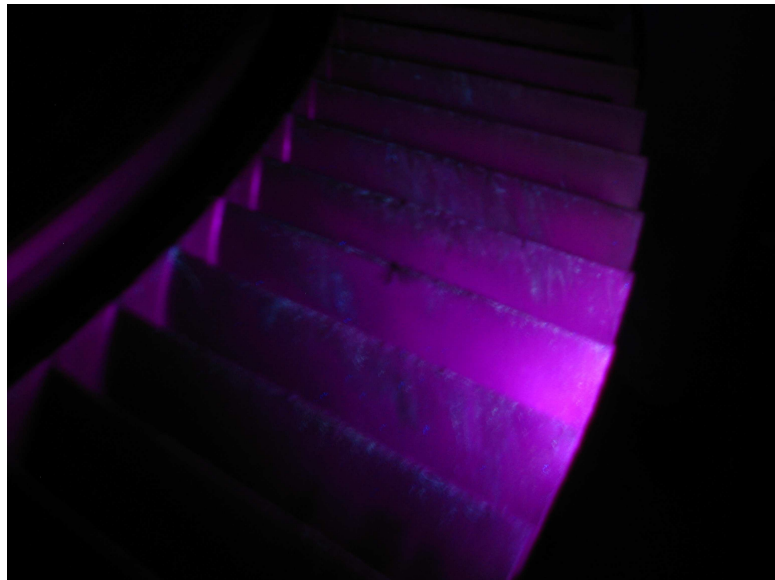

The low pressure compressor assembly was disassembled and each stage inspected individually using a black light. All the stages exhibited some debris deposits but no stage exhibited soft body deformation. The below table provides the debris noted on each stage and the reference to clock position is Forward Looking Aft. All the rotor disks were index marked to assembly position of each disk relative to the other.

Stator					Rotor				
Stage	# affected vanes	Side (concave (P)/convex (S))	# from 12:00 Clockwise		Stage	# affected blades	Side (concave (P)/convex (S))	# from 12:00 Clockwise	Degree from index mark
					1 (fan)	3	P	31	242°
					1 (fan)	2	P	42	329°
1	1	P	4		1.5	8	S	68	226°
1.5	14	P	49		2	12	S	92	276°
2	15	P	42		3	10	S	101	324°
3	17	P	38		3	24	P	106	340°
					4	22	P	18	64°

Inspection of Engine Nr4 – ESN 702082

A black light inspection of the fan blades revealed indications of organic debris under the mid-span shroud at blade No. 10 and on the concave side of blade No. 12.

Analysis of the organic residues.

Samples were taken of the organic residues, and they were sent to the Smithsonian Institute for investigation.

The Smithsonian Institute Museum of Natural History – Bird Division performed an inspection on the remains, as well as DNA analysis.

The results were consistent with the characteristics of the European Kestrel (*Falco Tinnunculus*).



The **European Kestrel** (*Falco tinnunculus*) is a bird of prey species belonging to the falcon family.

The Common Kestrel is small compared with other birds of prey, but larger than most songbirds. Kestrels have long wings as well as a distinctive long tail like the other *Falco* species.

Common Kestrels measure 34 – 38 cm from head to tail, with a wingspan of 70 – 80 cm. The average adult male weighs around 155 g with the adult female weighing around 184 g.

The common Kestrel is a bird species protected by the Law of 9 September 1981. It is forbidden to use lethal methods for the dispersal of such bird.

During a visit of the Bird Control Unit at Brussels Airport, several Common Kestrel were observed, one of which was hovering above Runway 25R. The BCU used the distress signal and pyrotechnic charge to scare the bird away, with some limited success – the bird came back as soon as the BCU left the area -.

1.17. Organisational Aspects

Kalitta Air.

Kalitta Air is a FAR-121 American cargo airline based in Ypsilanti, Michigan, USA. The company was created in November 2000 by Mr Conrad Kalitta. It operates international scheduled and ad-hoc cargo charter services. Its main base is Willow Run Airport, Ypsilanti.

The fleet, at the time of the crash was composed of 18 aircraft, mostly B747-classic (freighters). Since the crash, Kalitta bought 2 B747-400, and has further plans to increase its fleet with this type of aircraft.

Kalitta employs a total of 1486 employees, amongst which a total of 364 flight crew.

The training of the flight crew is mostly done in-house. Kalitta operates one B747-200 flight simulator at the company headquarter in Ypsilanti, Michigan.

Kalitta has a FAR-145 maintenance center in Oscoda with 425 FAA licensed technical engineers.

At the time of the accident, Kalitta Air operated through Brussels with an average of 26 flights (departures from EBBR) a month, on the following routes.

Route : New-York (KJFK) – Bruxelles (EBBR) – Bahrain (OBBI).
Dubai (OMDB) - Bruxelles (EBBR) – New-York (KJFK).

Kalitta Air operates also through EBLG on a daily base on the route Newark / LGG / BAH.

A few flights (3 in 2008) transit through EBOS.

Procedures.

Kalitta Air is operating in accordance with a General Operations Manual, accepted by the FAA. This manual sets forth the policies and procedures by which Kalitta Air complies with the Operations Specifications issued by the FAA and the current Federal Regulations.

With respect to the rejection of the takeoff, the GOM states:

REJECTED TAKE-OFF

The Captain will always make the decision to reject a takeoff.

It is important that all crewmembers communicate effectively during the takeoff. If anything abnormal is observed, call it out loudly and clearly. Make sure the words you use transmit the proper message; “Loss of Essential Power” (clearly an electrical problem) vs “Loss of Power”.

First Officers and Flight Engineers should not use the words “reject” or “abort” unless they are confirming their understanding of what the captain has commanded.

It may be safer to reject a takeoff when approaching V1 only if there is doubt of the aircraft's ability to maintain flight. The problem may be more safely handled as an in-flight problem than as a rejected takeoff.

At or after V1, unless a malfunction occurs that renders the aircraft uncontrollable, do not reject the takeoff. Statistics indicate that rejected takeoffs at V1 are very seldom successful.

BCAA inspections.

Besides the monitoring of the airline by the US FAA, the BCAA Inspection Directorate performs inspection on foreign operators flying into Belgium.

Kalitta Air was inspected 7 times in 2008, a normal frequency for such an operator;

- 1 general inspection (SAFA);
- 4 inspections on the transport of dangerous goods;
- 2 inspections on ground operations.

These inspections revealed no anomaly.

The N704CK was last inspected in June 2007, no anomaly was reported.

2. Analysis.

2.1. General

The aircraft was maintained in accordance with the prevailing FAA requirements.

The analysis of the EPR data determined that engine Nr 3 did experience a loss of power.

2.2. Take-off parameters

The take-off parameters were computed with the On-Board computer system (OPS). The computation was verified and found conform to the Boeing data.

The take-off parameters were computed with the ATIS "S" data showing a wind of 6 knots with a direction of 210 degrees. This was translated by the system as 06H / 01X, rounding up an exact value of 5.9H / 1.04X.

Upon take-off, the conditions changed somewhat, the ATC gave the wind conditions as 220 degrees - 4 knots. The ATIS at roughly the same moment showed that the wind further dropped to 2 knots (ATIS "U" direction 240 degrees). This would translate into 1.5H / 1.3X. The ATIS "U" was available when the aircraft was holding.

This had a negative impact on the take-off run, and thus on the stop margin.

2.3. Engine stall

In a jet engine, air compression is achieved aerodynamically by an axial flow compressor, as the air passes through the stages of the compressor. If the air flow is disrupted, the compressor can no longer deliver compressed air to the combustion chamber. In many cases, the high-pressure condition existing behind the stalled area may create a flow reversal towards the compressor air inlet, causing an immediate thrust loss.

An engine stall can be caused by:

- an engine internal deterioration, such as the rupture of a compressor blade,
- the ingestion of foreign objects, such as a bird, or ice,
- an engine controls malfunction, fuel scheduling, or stall protection devices,
- a local disturbance of the air flow around the engine, known for example on inboard engines of B747 in case of side winds.

At take-off and high power settings, an engine stall is characterized by;

- one or more loud bangs,
- instant loss of thrust, resulting in a yaw movement,
- engine parameters fluctuation,
- visible flames from the inlet and/or the tailpipe

Flight crews who have experienced an engine stall at takeoff report that the bang is louder than any other noise they had previously heard in the cockpit. It is often compared to a shotgun being fired a few meters away.

In the case of N704CK, both the FDR and the inspection performed on engine showed that the stall was caused by the ingestion of a bird into the core engine (compressor). The noise analysis showed further that the engine appeared to be recovering immediately after the engine stall. There was no damage found during the engine examination that would indicate otherwise.

Engine are designed and certified to continue to operate in extreme conditions, in order to provide enough reaction time to the crew to cope with the problem. As part of the certification process, the engine resistance to the ingestion of bird is being tested. An engine such as the PWA JT9D-7Q was tested at take-off thrust;

- to be able to withstand the strike of a 3.65kg bird, without catching fire and without releasing hazardous fragments through the engine casing.
- to be able to withstand the simultaneous ingestion of smaller birds (4 weighing 1 kg each) without losing more than 25% thrust.

Furthermore, a 4-engine aircraft is certified to be able to continue the take-off with the total failure of one of its engines.

2.4. Engine problems.

The fleet of Kalitta Air has experienced a series of engine problems in the past. Amongst others, there were:

- October 2004: N709CK loses an engine that falls into lake Michigan. The cause of this accident was maintenance-related, but the maintenance of Kalitta was not involved.
- 12 engine incidents on Take-Off were recorded since 2006; 4 involved N704CK.
- The Captain personally experienced one of the above-mentioned incidents; in Incheon “loud bang, flash of light, a/c yawed to the right”.
- 27 engine-related incidents on N704CK were recorded since January 2004, which is higher than the average of the rest of the fleet.
- Engine 3 was replaced 1 month before, after reporting of engine fire warning.
- Engine 4 was also recently replaced (no incident-related).

The In Flight Shut Down (IFSD) rate of the PWA JT9D-7Q is higher than most other engines installed on the current B747, such as the GE CF-6 or PWA 4000. The IFSD recorded by Kalitta Air for its own fleet is slightly higher than the world average, but this is mostly due to its policy of precautionary Shut down in flight (ao 2 cases in July and Nov in EBLG).

The higher number of engine incidents on N704CK seems coincidental, since it involves different engines each time.

The inspection on the engine did not reveal any internal failure prior to the crash. This is confirmed by the analysis of the flight data recorder and the statements of the crew.

2.5. Pilot's impressions.

Based on the statements made by the crew, we can assume that the decision of the pilot to reject the take-off was influenced by several impressions.

- the take-off performances were computed for a "wet" runway. Upon lining-up, the crew saw the runway, and "it looked dry" to them. The difference in computation between a "wet" and a "dry" runway is mostly in the take-off margin, i.e. the remaining distance to the end of the runway after a rejection at V1. The state of the runway may have given the crew the impression they had a better take-off margin than originally computed.

Note: the Take-Off distance is computed without the actions of the Thrust Reversers.

- These performances showed a take-off margin of 300m, but this distance takes the whole runway length into consideration. In reality, the aircraft lined up at the B1 intersection, shorter by 300m. The crew was under the impression they started with a positive take-off margin, while this margin was reduced to zero.
- When lining up on runway 20, the pilot widened his turn, in order to "cheat themselves a few more meters of margin".
- The engine stall occurred at mid runway length. At this position, the slope of the runway increases from 0.62% to 0.93%. Although not seen on the FDR, this might have given the pilot the impression the aircraft slowed down. In his statement, the pilot said "he was under the impression the aircraft could not fly" after he heard the bang.
- The engine stall caused a loud bang, probably as loud, if not louder as the one the pilot experienced in Incheon with this very same aircraft, a few years back. It was a genuine engine failure then. The sound of the bang could have given the pilot the impression it was caused by something worse than what happened in Incheon.

The crash is not due to an engine failure, but the history of engine incidents, as well as the personal experience of the pilot with this aircraft could have had an influence on the reactions of the crew.

The pilot furthermore stated he did not take a breakfast that morning. This could possibly influence the reaction rate of a person owing to a lowered blood glucose level.

2.6. Reject manoeuvre

Thrust Reverser

The crew did not operate the thrust reversers during the stop roll, as confirmed on the FDR, resulting in a constant deceleration during the reject phase. Even though the pilot suspected one of the engine would be inoperative, there was still braking power available from the thrust reversers (2 symmetrical engines). Kalitta Air procedure requires the use of thrust reversers in the case of a Reject Take-Off.

Brakes

The pilot stated he applied maximum braking power during the stop run.

Manual braking inputs by the pilot or first officer would result in up to 3000 psi hydraulic pressure being supplied to the brake system. The antiskid system (if selected ON) provides protection against excessive tire skidding by reducing brake pressure to wheel positions if a skid is detected (individual wheel protection for Normal antiskid; paired wheel protection for Alternate antiskid).

The Boeing B747 brake energy chart for aborted takeoff or maximum braking shows an accumulated energy of 44.10⁶ ft-lbs (maximum speed 152kts). The maximum available brake energy level is 45.10⁶ ft-lbs. This level is in the danger zone of the brake energy chart, where tires are likely to deflate and wheel fires must be anticipated.

On the wreckage, 14 out of 16 tires were found intact after the aircraft was stopped.

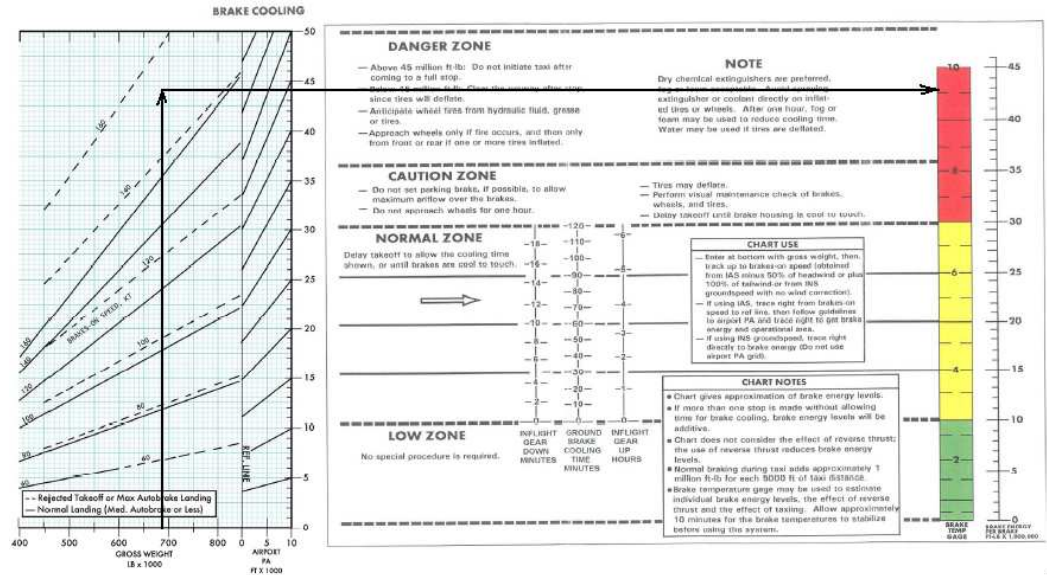

Speed Brakes

The pilot stated he applied speed brakes.

During a Reject Take-Off (RTO), one essential braking system is the speed (air) brakes as the extension of the speed brakes would dump lift from the wings and transfer the weight to the wheels and brakes for better braking; it gives also an aerodynamic braking effect, by increasing the drag ; more important at high speed, and decreasing rapidly as the speed goes down.

The speed brake lever was found in the retract position in the cockpit, while the speed brakes themselves seemed in a stowed / retract position.

Boeing performed an analysis of the brake performance in an attempt to determine if the spoilers were deployed during the RTO.

The analysis was done for airspeed between 70 (72 kts is the speed at which the airplane exited the runway) and 120 Knots.

Appendix 2 shows 2 Figures providing a plot of FDR deceleration in ft/sec² as a function of indicated airspeed.

Figure 1 shows the above-mentioned FDR deceleration along with the estimated deceleration as a function of airspeed with spoilers extended for both dry and wet runway.

Figure 2 shows the same FDR deceleration, but with the estimated deceleration with spoilers stowed for both dry and wet runway.

The FDR deceleration with airspeed is greater than calculated. The estimated deceleration is based on a constant airplane braking coefficient, which for spoilers extended are 0.2810 and 0.20 for dry and wet runway respectively. The greater rate of change of the FDR deceleration at lower airspeed when compared to the calculated rate of change may be explained by variable runway friction, i.e. the runway texture may contain more moisture or a combination of runway rubber deposit and moisture closer to the end of the runway.

The rate of change or slope of the estimated deceleration with airspeed is less for spoilers stowed (even lesser with decreasing runway friction) when compared to spoilers extended. There is a better match between recorded and estimated deceleration with spoilers extended compared to spoilers stowed, especially between 105 knots and 120 knots. This may indicate that the spoilers have a higher likelihood of being extended than stowed during the RTO, however, due to limited information, the position of the spoilers are inconclusive.

Brake performance analysis

Boeing performed an analysis on the braking performance of the airplane, and computed the estimated actual all engine operating distance from Brake Release (BR) to V1 and the one engine inoperative distance from V1 to stop with the spoilers stowed or extended. Data are provided for both dry and wet runways. Wet runway in this study is defined as runway with reported braking action good.

As a reminder; the computation of performances give a V1 speed (ultimate speed at which the rejection of a take-off may be initiated),

For a dry runway: V1 = 148 Knots Indicated Air Speed.

For a wet runway: V1 = 138 KIAS.

From the FDR data the maximum speed during the Rejected Take-Off (RTO) is approximately 152 Knots.

Table 1: Dry Runway

RTO Speed	Distance from BR to RTO speed - ft	Distance from V1 to stop - ft			
		Spoilers Extended		Spoilers stowed	
		2 Rev.	No Rev.	2 Rev.	No Rev.
138	4267	3092	3279	3177	3383
148	5020	3483	3699	3594	3833
152	5343	3645	3872	3767	4020

Table 2: Wet Runway

RTO Speed	Distance from BR to RTO speed - ft	Distance from V1 to stop - ft			
		Spoilers Extended		Spoilers stowed	
		2 Rev.	No Rev.	2 Rev.	No Rev.
138	4267	3868	4202	4269	4707
148	5020	4351	4731	4874 (*)	5391 (*)
152	5343	4550 (*)	4949 (*)	5127 (*)	5680 (*)

(*) The computed total distance (accelerate stop distance) exceeds the runway length of 9800 feet.

The 747-200F/7Q registered N704CK initiated an RTO at approximately 152 knots indicated. At this speed, with 9800 ft runway it should theoretically be possible to stop before the end of the runway if runway is dry with or without reversers and with spoilers either stowed or extended. For a wet runway, it would not be possible to complete an RTO without doing a runway overrun even if spoilers were extended and with 2 thrust reversers operating.

3. Conclusions.

3.1. Findings

- The crew was adequately trained, and had sufficient experience.
- The aircraft was airworthy at the moment of the crash.
- The airport and facilities complied to the national and international requirements at the time of the crash.

3.2. Cause and contributing factors.

The accident was caused by the decision to Reject the Take-Off 12 knots after passing V1 speed.

The following factors contributed to the accident;

- o Engine Nr 3 experienced a bird strike, causing it to stall. This phenomenon was accompanied by a loud bang, noticed by the crew.
- o The aircraft line up at the B1 intersection although the take-off parameters were computed with the full length of the runway.
- o The situational awareness of the crew,
- o Less than maximum use of deceleration devices.
- o Although the RESA conforms to the minimum ICAO requirement, it does not conform to the ICAO recommendation for length.

4. Safety recommendations.

4.1. Kalitta's training program

We recommend to modify the training program of the flight crew (initial and recurrent), and related documentation, to highlight the risks involved in rejecting TO around V1, as well as the importance of respecting procedures.

The training program of Kalitta was amended and an in-house DVD training video was developed, that demonstrates proper and improper reject procedures that is modeled after rwy 20 in BRU. The content of the DVD was reviewed by both Boeing and FAA. This revised training program is currently in place.

4.2. The RESA.

We recommend to extend the RESA of Runway 20 of EBBR to the length recommended by ICAO, either thru physical extension, or by the use of the EMAS system discussed in chapter 1.10, or by any other suitable means, and evaluate the need to apply this recommendation to other runways and Belgian airports.

4.3. The Bird Control Unit.

The Bird Control Unit of EBBR should be reinforced.

- The leader of the BCU should be dedicated to the task. The function is currently held part-time by an airport inspector.
- Training should be improved to involve all topics related to wild life in an airport environment; it is currently limited to get a hunting licence.

The bird control methods are currently limited by general law on hunting. Dispersal by lethal method are therefore limited to determined time frame (hunting season), and prohibited for protected species such as the one having caused the bird strike.

A request for a waiver on these requirements should be considered (as granted for other international airports, such as Schiphol).

4.4. Communication

The Aeronautical Information Publication issued by Belgocontrol did not formally required flight crew to notify the Tower when the use of the full length of runway 20 was required. For runway 25R, however, a dedicated sentence to that purpose was included.

Belgocontrol revised the AIP to include the same requirement for Runway 20.

APPENDIX 1: FLIGHT DATA RECORDER READ-OUT

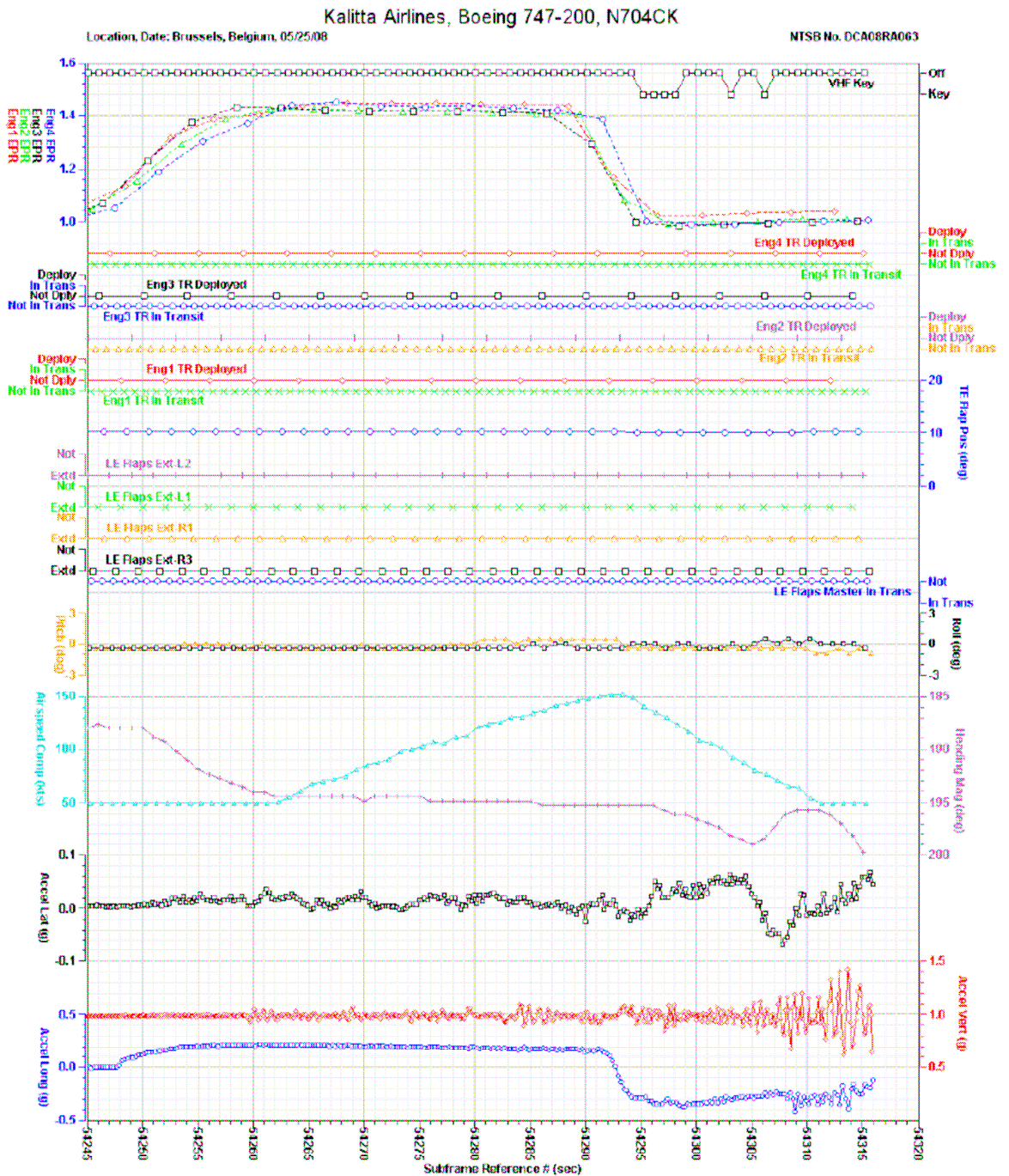

Revised: 5 November 2008

Accident Take-Off Roll - Engines & Flaps

National Transportation Safety Board

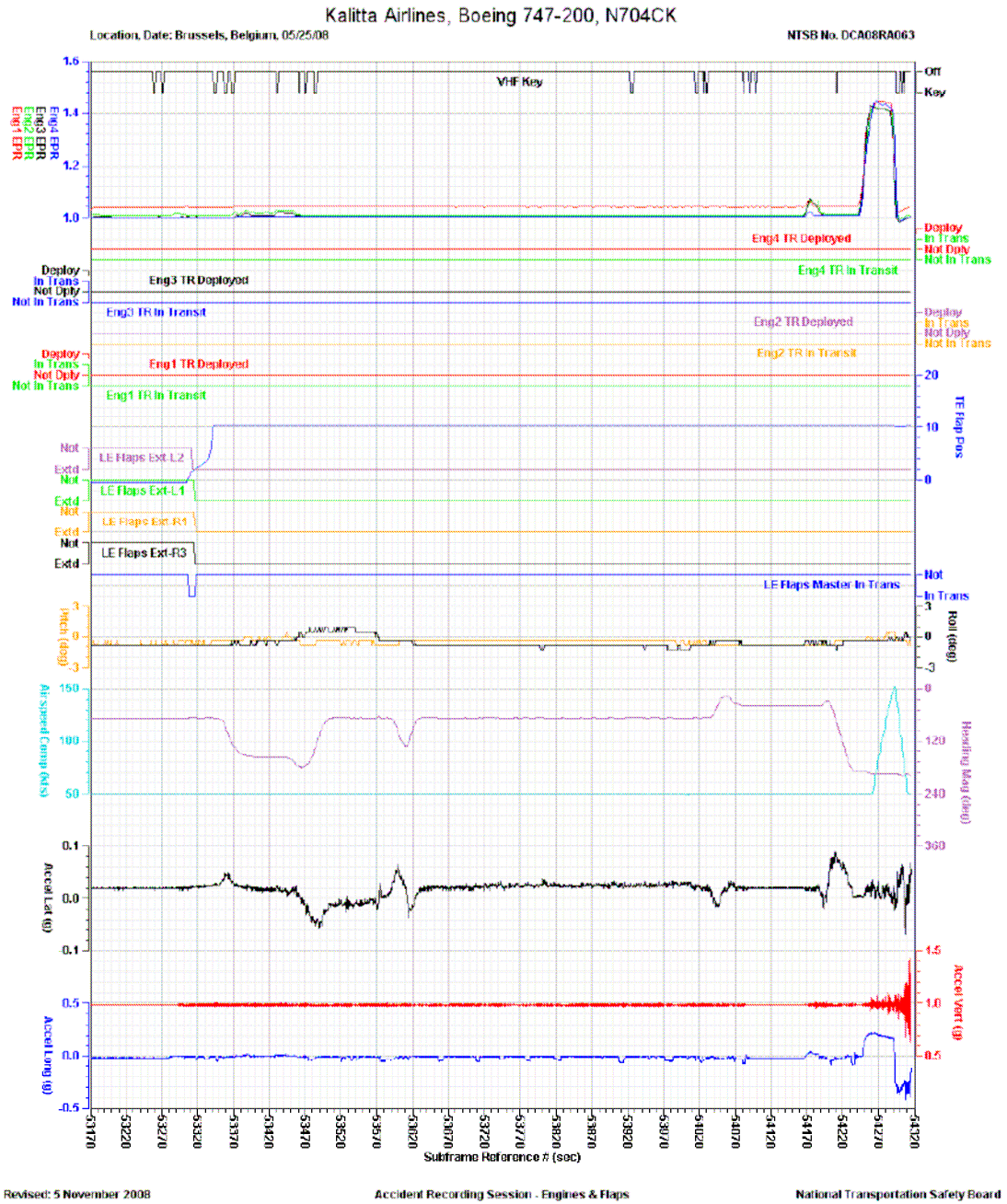

Plot 2

Kalitta Airlines, Boeing 747-200, N704CK

Location, Date: Brussels, Belgium, 05/25/08

NTSB No. DCA08RA063

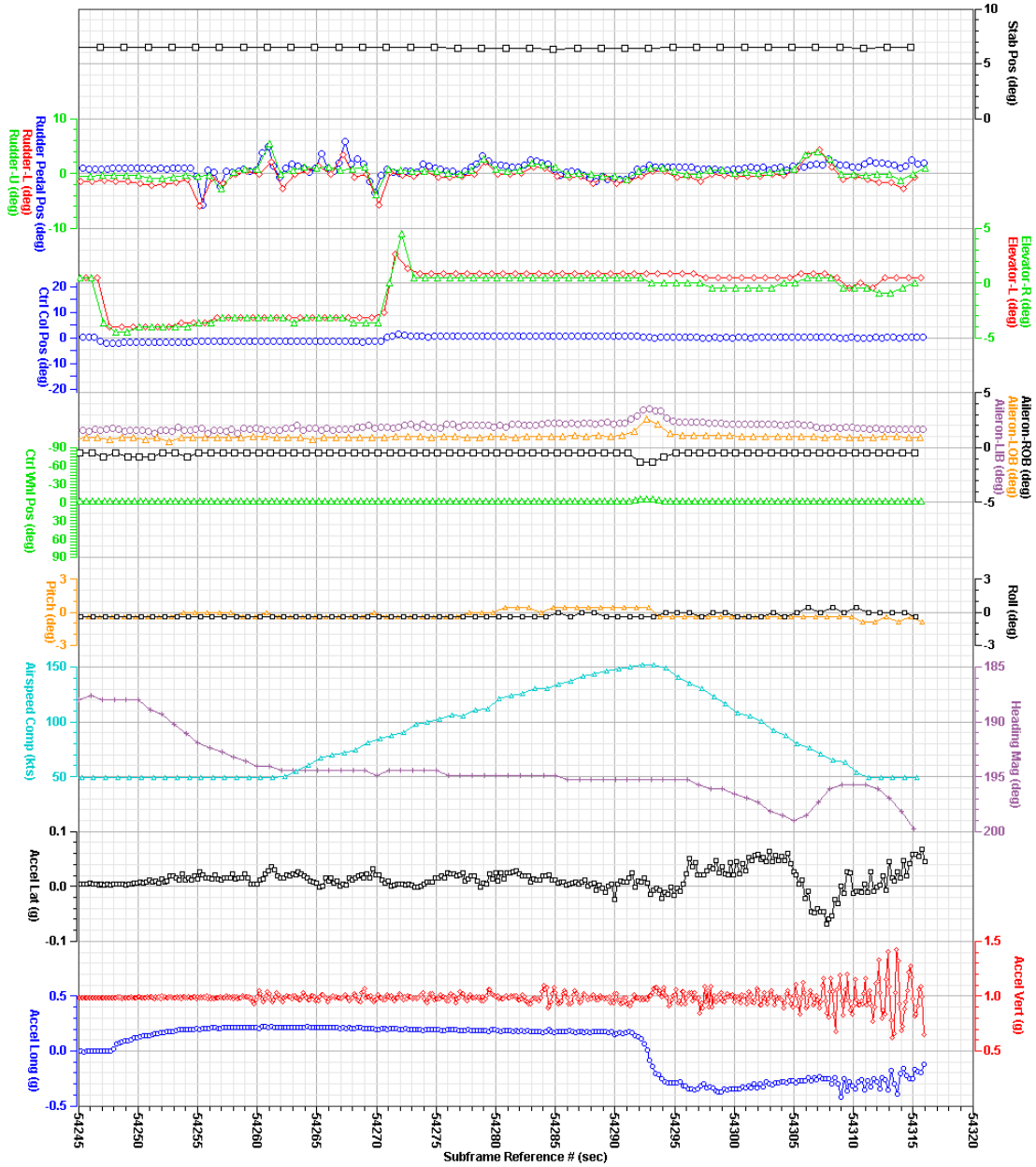

Revised: 5 November 2008

Accident Take-Off Roll - Control Inputs & Surfaces

National Transportation Safety Board

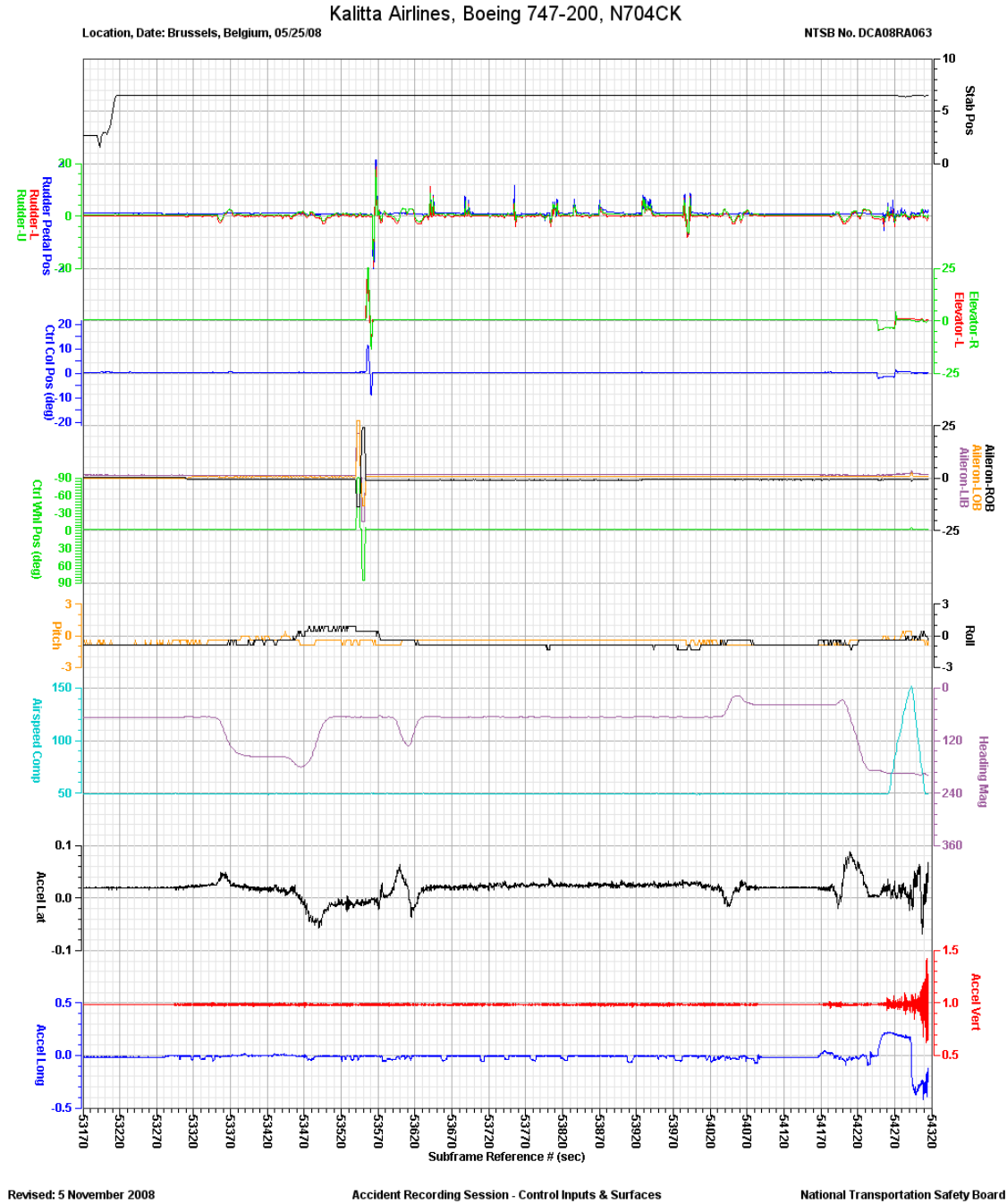

APPENDIX 2: BRAKING PERFORMANCE ANALYSIS

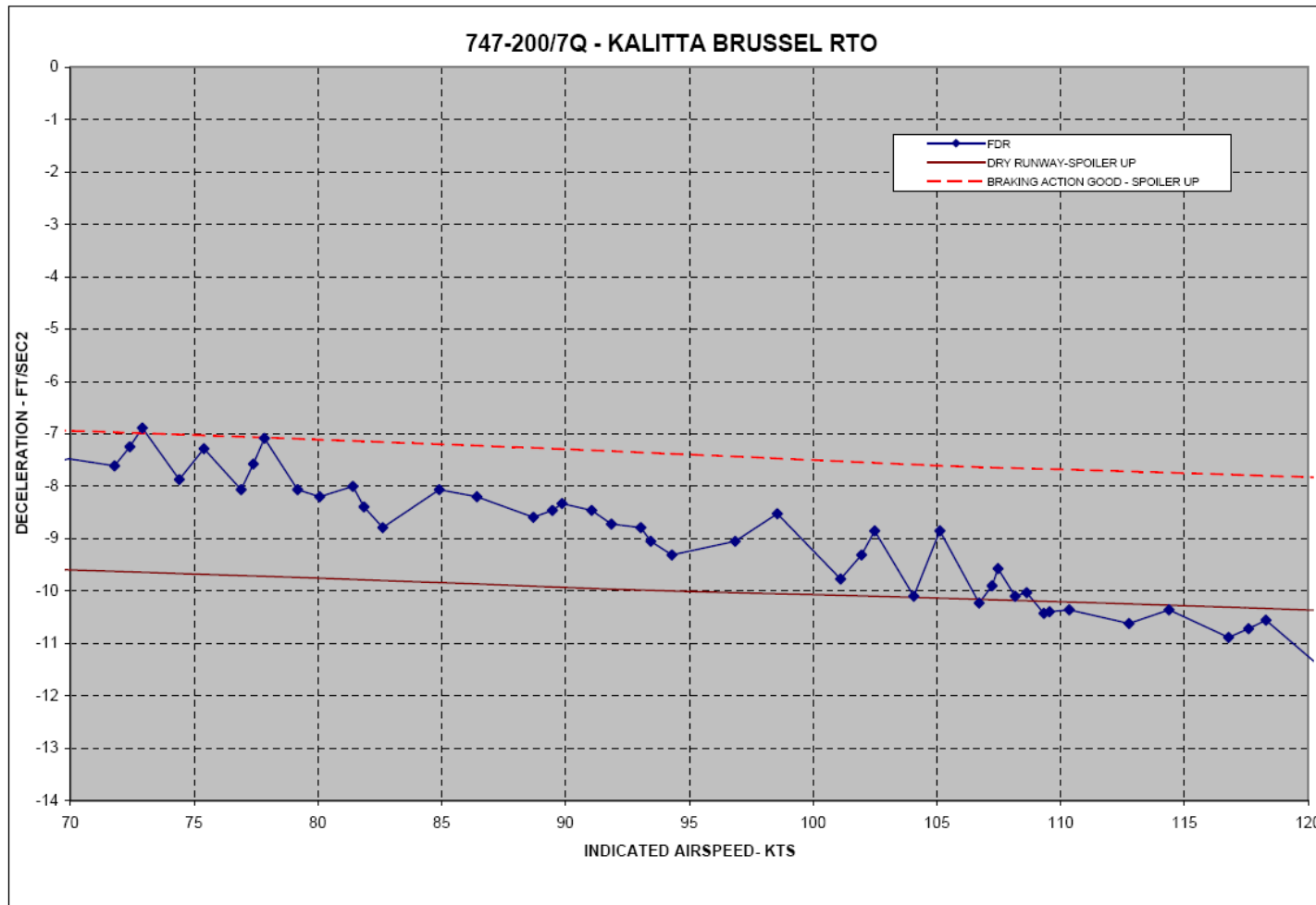

Figure 1: FDR deceleration in ft/sec2 as a function of indicated airspeed along with the estimated deceleration as a function of airspeed with spoilers extended for both dry and wet runway.

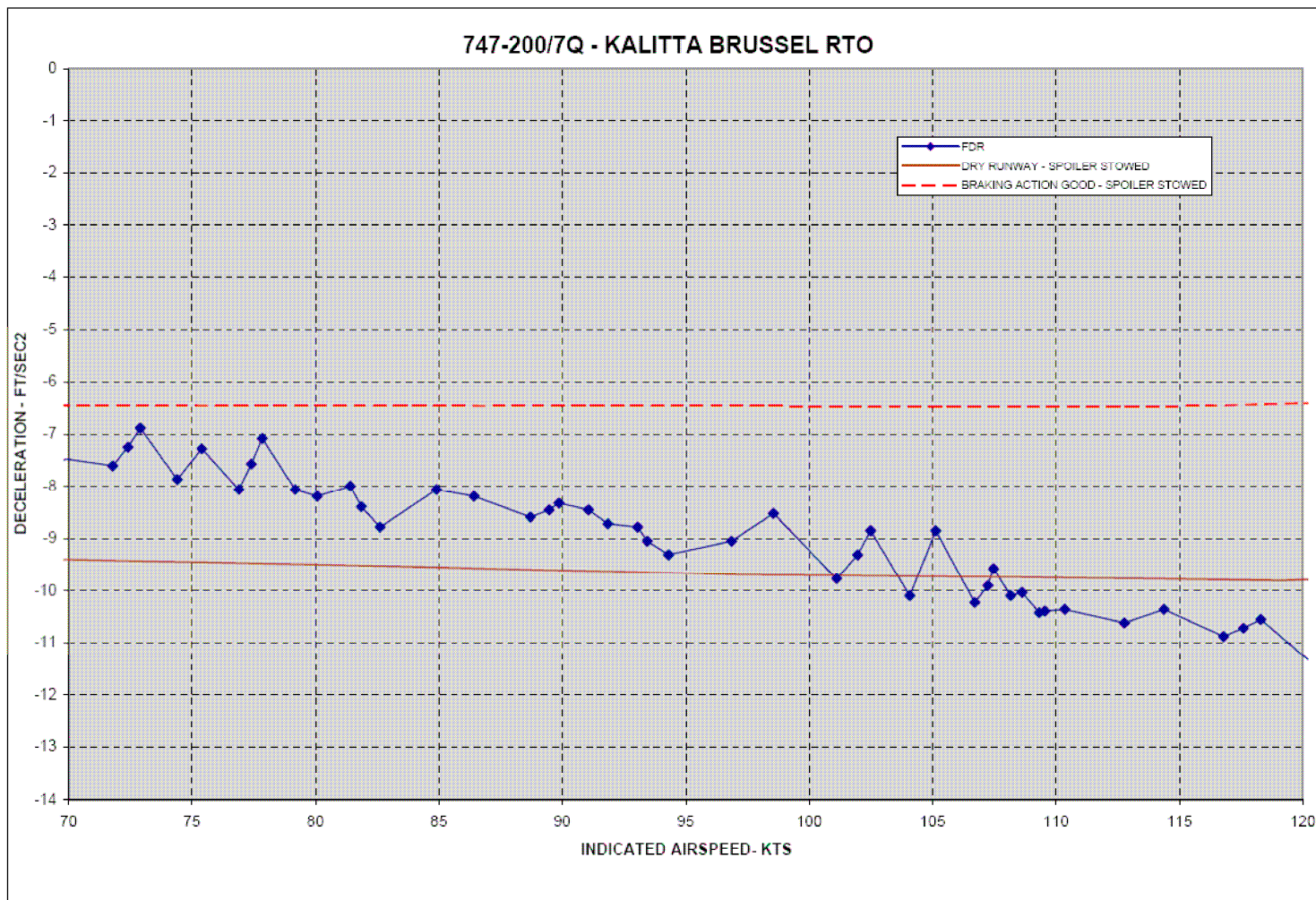

Figure 2: FDR deceleration in ft/sec2 as a function of indicated airspeed along with the estimated deceleration as a function of airspeed with spoilers stowed for both dry and wet runway.

APPENDIX 3: CALCULATED GROUND TRACK

